

The DEHN logo is positioned in the upper right corner of the top image. It consists of the word "DEHN" in a bold, white, sans-serif font, flanked by two white chevron-like shapes pointing outwards.

Lightning and surge protection for biogas plants

White Paper



Contents

- Necessity of a lightning protection system
- External lightning protection
- Fermenters with film roofs
- Design service
- Fermenters made of metal sheets
- Steel tanks
- Earthing concept
- Feeding electricity into the grid
- Remote monitoring
- Process control

Lightning and surge protection for biogas plants

White Paper



In modern biogas plants, biodegradable organic substrates such as manure, dung, grass, straw, green waste, residue from the production of sugar, wine and beer, leftover food and grease are fermented in an air-tight container (fermenter). In this oxygen-free atmosphere, bacteria produce biogas from the fermentable, organic biomass components. This biogas is used to generate heat and electricity.

Figure 1 shows the basic principle of a biogas plant. Biogas plants frequently consist of feed-in systems for solids and/or liquid substrates, one or more heated fermenters, a storage tank, perhaps a post-fermenter, a gas tank and maybe a gas treatment unit. The gas engine with heat exchanger and a generator connected to it is called a combined heat and power station (CHP). Depending on the energy content of biogas, a combined heat and power station generates electricity with an efficiency of about 30 % and heat with an efficiency of about 60 %. While the electricity is fed into the public power grid, some of the heat is used for heating the fermenter and the waste heat is used, for example, to heat residential and agricultural buildings.

Necessity of a lightning protection system

Different hazards and risks for people, the environment and system technology may arise during the generation, storage

and energy recovery of biogas. To be in a position to take adequate precautions and protection measures, potential risks which might lead to disturbances or dangerous events are considered in a risk analysis according to the German Federal Immission Control Act (BImSchG)/Ordinance on Industrial Safety and Health (BetrSichV).

The German Safety Regulations for Agricultural Biogas Plants published by the German Agricultural Professional Association as well as the German BGR 104 specify that measures which prevent the ignition of dangerous explosive atmospheres must be taken in potentially explosive atmospheres to avoid ignition sources.

According to sub-clause 5 of the EN 1127-1 standard, there are thirteen different ignition sources. In sub-clause 5.7 of the EN 1127-1 standard and in the German BGR 104, lightning is defined as a possible source of ignition: "If lightning strikes in an explosive atmosphere, ignition will always occur. Moreover, there is also a possibility of ignition due to the high temperature reached by lightning conductors. Large currents flow from where the lightning strikes and these currents can produce sparks in the vicinity of the point of impact. Even in the absence of lightning strikes, thunderstorms can cause high induced voltages in equipment, protective systems and components".

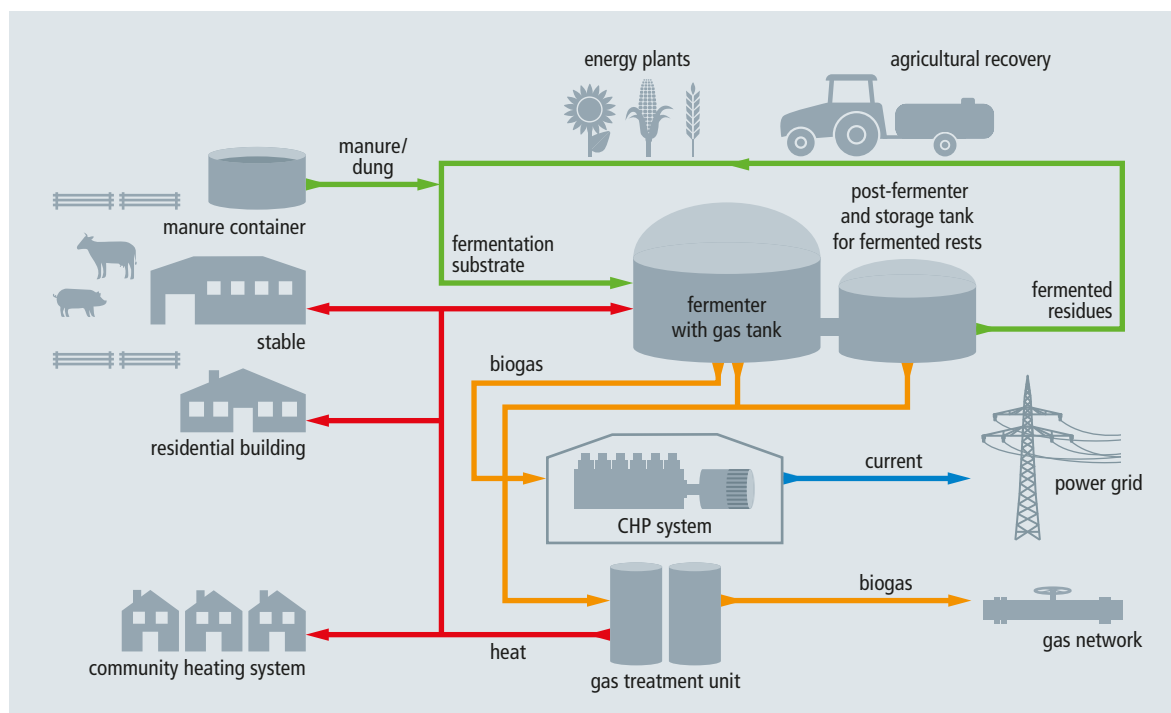

Figure 1 System overview of a biogas plant

Lightning and surge protection for biogas plants

White Paper



A risk analysis according to the calculation method specified in IEC 62305-2 (EN 62305-2) must be performed to define the relevant protection measures. The purpose of this risk analysis is to determine the risk resulting from direct and indirect lightning strikes for a structure including the persons and equipment therein. If the risk is higher than the tolerable risk, lightning protection measures must be taken to minimise the risk resulting from a lightning strike so that it is no longer higher than the tolerable risk.

Supplement 2 of the German DIN EN 62305-3 (VDE 0185-305-3) standard includes additional information on special buildings including requirements on lightning protection systems for biogas plants. According to this supplement, biogas plants should be protected by isolated air-termination and down-conductor systems if the risk of ignitable sparks at contact and connecting points cannot be excluded.

External lightning protection

The fermenter, which is available in different designs, is the core of every biogas plant. Therefore, the required lightning protection system must always be adapted to the structural conditions of the fermenter. There are different solutions for the same protection goals. As mentioned in Supplement 2 of the German DIN EN 62305-3 (VDE 0185-305-3) standard, a lightning protection system with class of LPS II meets the general requirements for systems with a risk of explosion and thus those for biogas plants.

A lightning protection system consists of an external and internal lightning protection system.

The function of an external lightning protection system is to intercept all lightning strikes including side flashes to the structure, to conduct the lightning current from the point of strike to the ground and to disperse it in the ground without causing damage to the structure to be protected resulting from thermal, mechanical or electrical effects.

Fermenters with foil roofs

Fermenters with foil roofs are frequently used in biogas plants. If lightning strikes the foil roof of the fermenter, it will be damaged and melting and spraying at the point of strike may cause fire and explosion. Lightning protection measures must be taken to prevent lightning from directly striking the foil roof of the fermenter. (Figure 2).

The German Safety Regulations for Agricultural Biogas Plants define ,e.g., Ex zone 2 as the area within a radius of 3 m from the foil roof of the fermenter. In Ex zone 2 potentially explosive atmospheres only occur occasionally or for a short period of time. This means that a potentially explosive atmosphere is only to be expected in case of rare and unpredictable events (failure and maintenance work). Therefore, air-termination systems may be positioned in Ex zone 2 according to IEC 62305-3 (EN 62305-3).

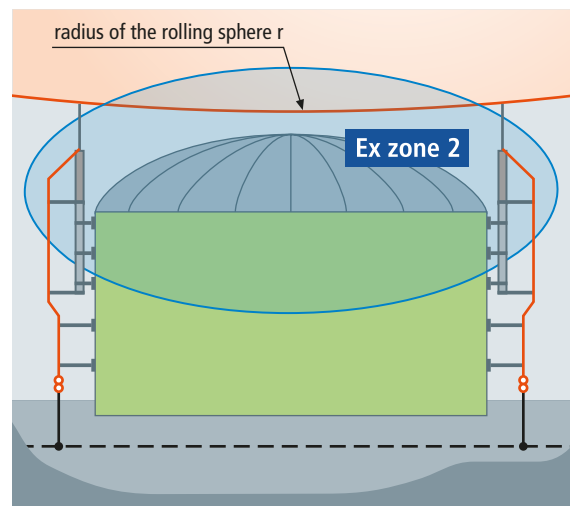

Figure 2 DEHNiso Combi system used to protect a fermenter with foil roof

Type	Part No.
DEHNiso Combi set, one-piece, total length of 5700 mm	105 455
Consisting of:	
1 StSt air-termination tip, 1000 mm long	105 071
1 GRP/Al supporting tube, 4700 mm long	105 301
3 wall mounting brackets made of StSt (V2A)	105 340
2 GRP/Al spacers, 1030 mm long	106 331

Table 1 DEHNiso Combi set

The rolling sphere method is used to determine the height and number of air-termination systems. The sag of the rolling sphere, which can be determined according to IEC 62305-3 (EN 62305-3), is decisive for dimensioning the air-termination system. In case of class of LPS II for systems with a risk of explosion, the rolling sphere radius is 30 m (Figure 2).

Depending on the gas volume, the inner membranes in the gas storage tank of the fermenter may touch the metal inner wall of the fermenter. An insulated down conductor is used to avoid uncontrolled flashover from the down conductor to the metal wall of the fermenter. The lightning protection system is electrically isolated from conductive parts of the fermenter since the down conductor is routed separately by means of spacers

Lightning and surge protection for biogas plants

White Paper

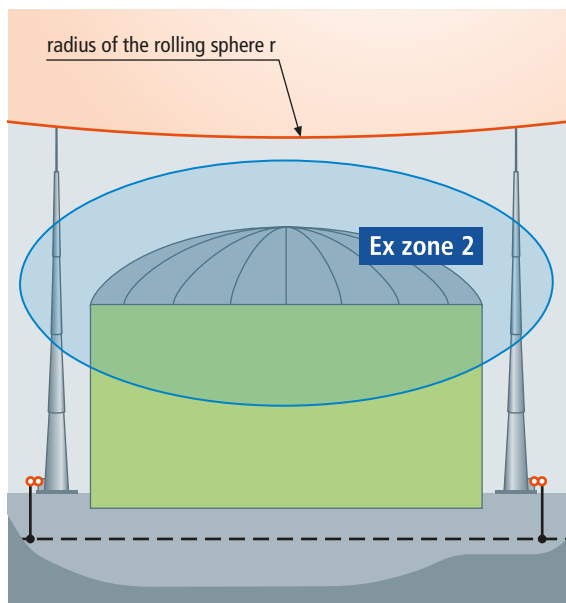

Figure 3 Protection of a fermenter with a foil roof by means of telescopic lightning protection masts

made of GRP (glass-fibre reinforced plastic). The length of the spacers depends on the separation distance determined according to IEC 62305-3 (EN 62305-3).

The DEHNiso Combi set according to **Table 1** is used for the application illustrated in **Figure 2**.

Another way to avoid direct lightning strikes to fermenters with foil roofs is to use steel telescopic lightning protection masts (**Figure 3**). These masts are installed in natural soil or in the ground foundations. Free heights above ground level of 25 m or in case of customised versions even higher can be achieved. More detailed information on the use of steel telescopic lightning protection masts can be found in installation instructions No. 1729.

A third method of protecting fermenters with foil roofs from direct lightning strikes is to use a HVI Conductor. HVI Conductors are high-voltage-resistant, insulated conductors with a special outer sheath. In the field of lightning protection, they are typically used as insulated down conductors for keeping the separation distance according to IEC 62305-3 (EN 62305-3). To this end, the separation distance must be calculated according to IEC 62305-3 (EN 62305-3). Then it must be checked whether this calculated separation distance can be achieved by means of the equivalent separation distance of the HVI Conductor. There are two possible solutions:

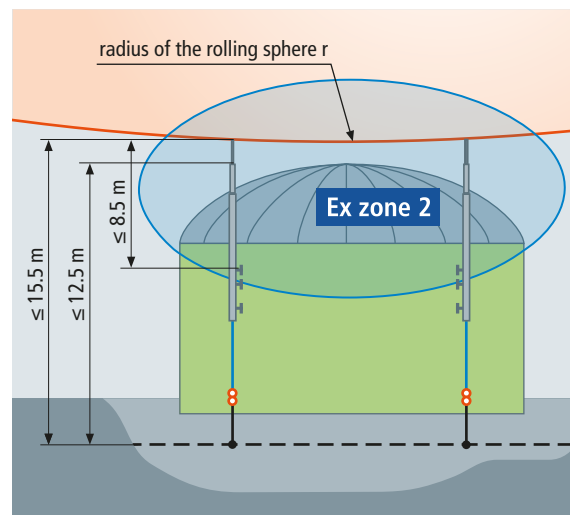

Figure 4 Protection of a fermenter by means of air-termination masts, isolated by means of a HVI Conductor (Part No. 819 730)

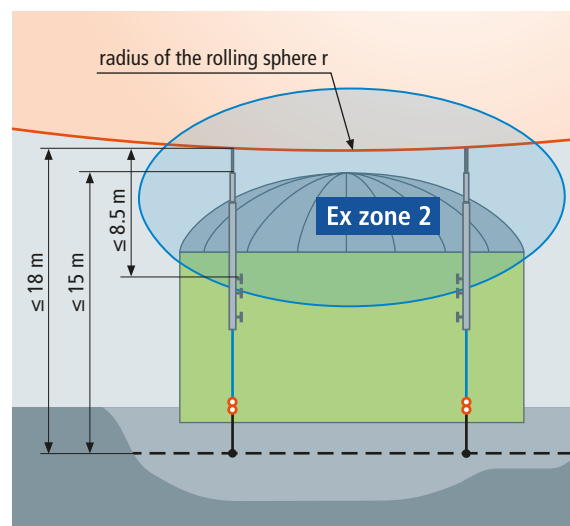

Figure 5 Protection of a fermenter by means of air-termination masts, isolated by means of a HVI-power conductor (Part No. 819 760)

➔ **Solution 1:** Air-termination masts with a HVI Conductor, pre-assembled – installed inside (**Figure 4**). The maximum total length of the air-termination system from the equipotential bonding level (earth-termination system) to the air-termination tip here is 15.5 m (in case of class of LPS II). The maximum free length above the top edge of the fermenter must not exceed 8.5 m (for mechanical reasons).

Lightning and surge protection for biogas plants

White Paper



Figure 6 Fermenter made of bolted metal sheets



Figure 7 Protection of a fermenter made of metal sheets by means of an isolated air-termination system (source: Büro für Technik, Hösbach)

➔ **Solution 2:** Air-termination masts with a HVI-power conductor, pre-assembled – installed inside (Figure 5). The maximum total length of the air-termination system from the equipotential bonding level to the air-termination tip here is 18 m (in case of class of LPS II). The maxi-

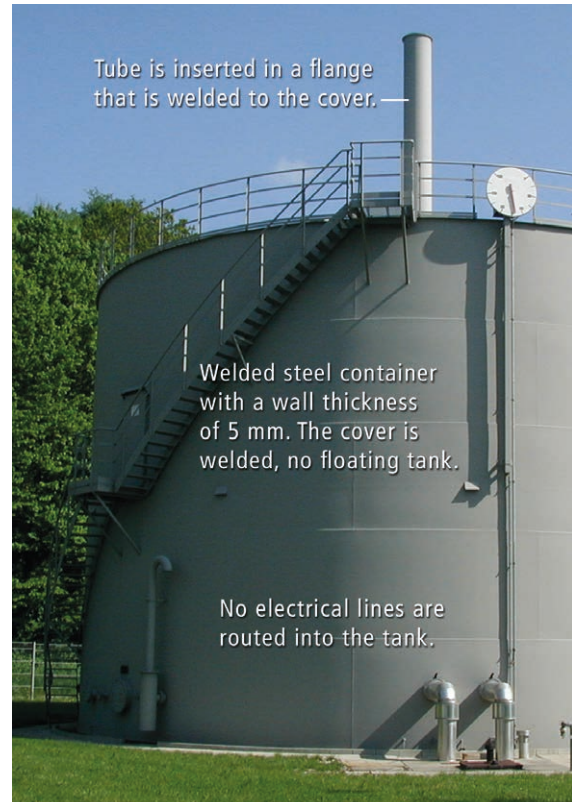

Figure 8 Welded steel container (source: Eisenbau Heilbronn GmbH)

imum free length above the top edge of the fermenter is also 8.5 m.

Design service

Isolated air-termination systems are complex and comprehensive systems. DEHN will be pleased to assist you in designing isolated air-termination systems based on HVI Conductors, the DEHNiso Combi system or steel telescopic lightning protection masts. This design service is available for a fee and comprises:

- ➔ Drawings of the lightning protection system (general layout drawings)
- ➔ Detailed drawings for the isolated air-termination system (in some cases in the form of exploded views)
- ➔ Comprehensive parts list of the components required for the isolated air-termination system
- ➔ Quotation based on this parts list.

If you are interested in our design service, please contact your local sales representative or our head office in Neumarkt, Germany at www.dehn-international.com.

Lightning and surge protection for biogas plants

White Paper



Fermenters made of metal sheets

Fermenters made of metal sheets typically have a thickness between 0.7 mm and 1.2 mm. The individual metal sheets are screwed together (Figure 6).

If the metal sheets are to be used as a natural air-termination system, they must have the right thickness, as listed in Table 3 of IEC 62305-3 (EN 62305-3). If the thickness of the metal sheets does not comply with Table 3 of IEC 62305-3 (EN 62305-3), a lightning strike may cause melting or impermissible heating at the point of strike resulting in a risk of fire and explosion. In this case, these fermenters must be protected

by additional air-termination systems to avoid melting at the point of strike. For this purpose, an isolated lightning protection system is installed. The rolling sphere method is used to determine the arrangement of the air-termination system. The down conductor is routed along the metal sheets by means of spacers according to the calculated separation distance (Figure 7).

Steel container

Figure 8 shows a biogas tank enclosed by fully welded steel sheets. According to Table 3 of IEC 62305-3 (EN 62305-3), a

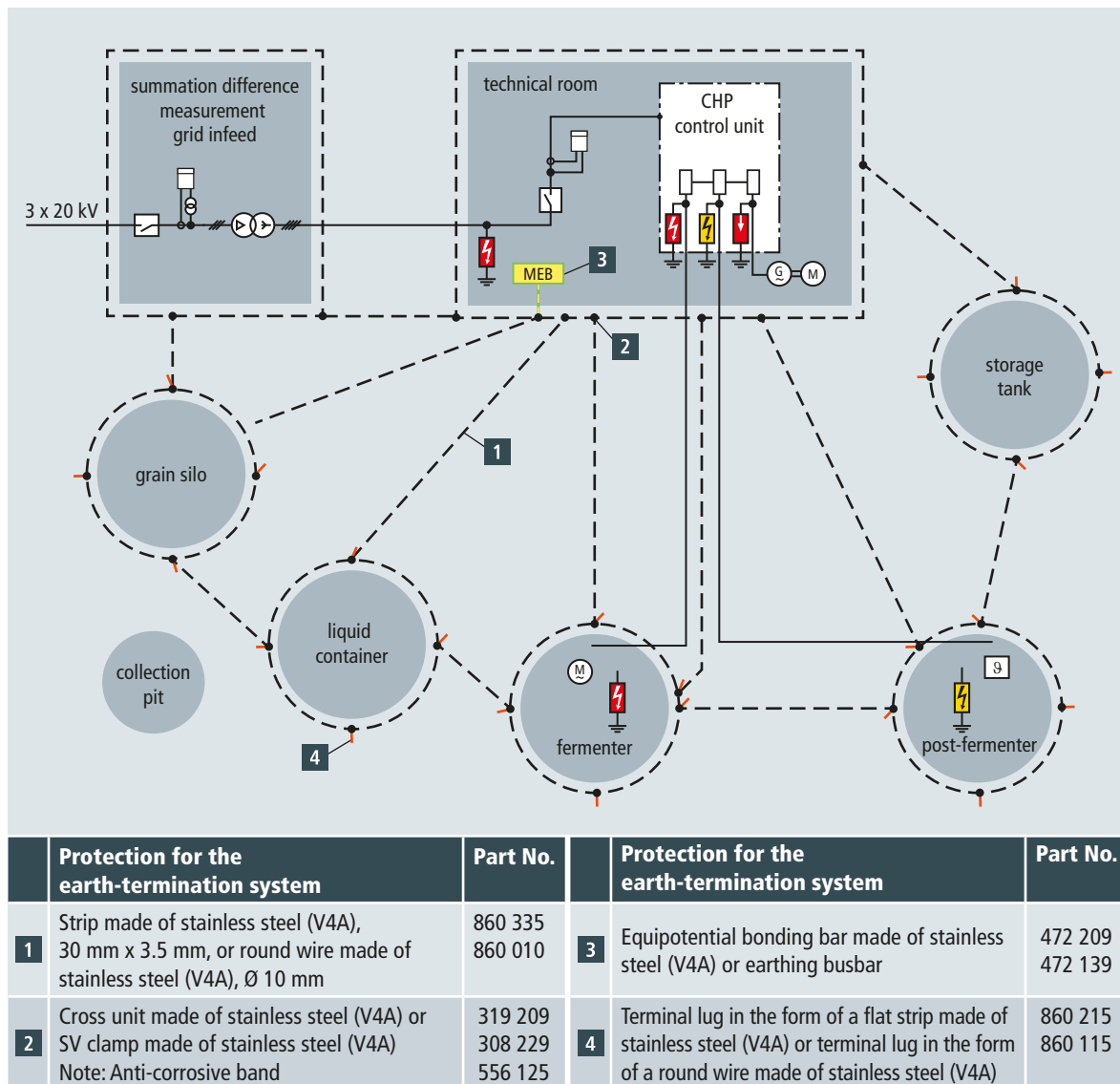

Figure 9 Intermeshed earth-termination system for a biogas plant

Lightning and surge protection for biogas plants

White Paper



minimum wall thickness of the enclosure of 4 mm is required for steel. The lightning protection system must meet the requirements in Annex D of IEC 62305-3 (EN 62305-3) "Additional information for LPS in the case of structures with a risk of explosion". If the Ex zones of exhaust openings are located in the protected volume of lightning current carrying metal parts of the enclosure, no additional air-termination systems are required. If this is not the case, additional air-termination systems must be installed to protect the exhaust openings from direct lightning strikes. These additional air-termination systems must have a lightning current carrying connection to the enclosure of the container without interfering with the anti-corrosion measures. If this cannot be ensured, an isolated lightning protection system (HVI conductor, DEHNiso-Combi) must be installed.

Earthing concept

To avoid high potential differences between the individual earth-termination systems, these are interconnected to create a total earth-termination system (Figure 9). This is achieved by intermeshing the individual earth-termination systems of the buildings and systems. Mesh sizes from 20 m x 20 m to 40 m x 40 m have proven to be economically and technically feasible. Intermeshing all earth-termination systems considerably reduces potential differences between the parts of the installation. It also reduces the voltage stress on the electri-

cal connecting cables between the buildings in the event of lightning effects.

Feeding electricity into the grid

The biogas produced is typically used in gas or pilot injection engines to generate electricity and heat. In this context, such engines are referred to as combined heat and power plants (CHP). These CHPs are located in a separate operations building. The electrical equipment, switchgear cabinets and control cabinets are housed in the same room or in a separate room of this operations building. The electricity generated by the CHPs is fed into the public grid (Figure 10).

Lightning equipotential bonding, which must be established for all conductive systems entering the building, is an integral part of a lightning protection system. Lightning equipotential bonding requires all metal systems to be incorporated in the equipotential bonding so as to cause as little impedance as possible and so that all live systems are indirectly integrated in the equipotential bonding via type 1 surge protective devices. Lightning equipotential bonding should be established as close as possible to the entrance point into the structure to prevent partial lightning currents from entering the building. The incoming 230/400 AC lines of the main low-voltage distribution board of the consumer installation (Figure 10) are protected by type 1 surge protective devices (SPDs). DEHNventil, for ex-

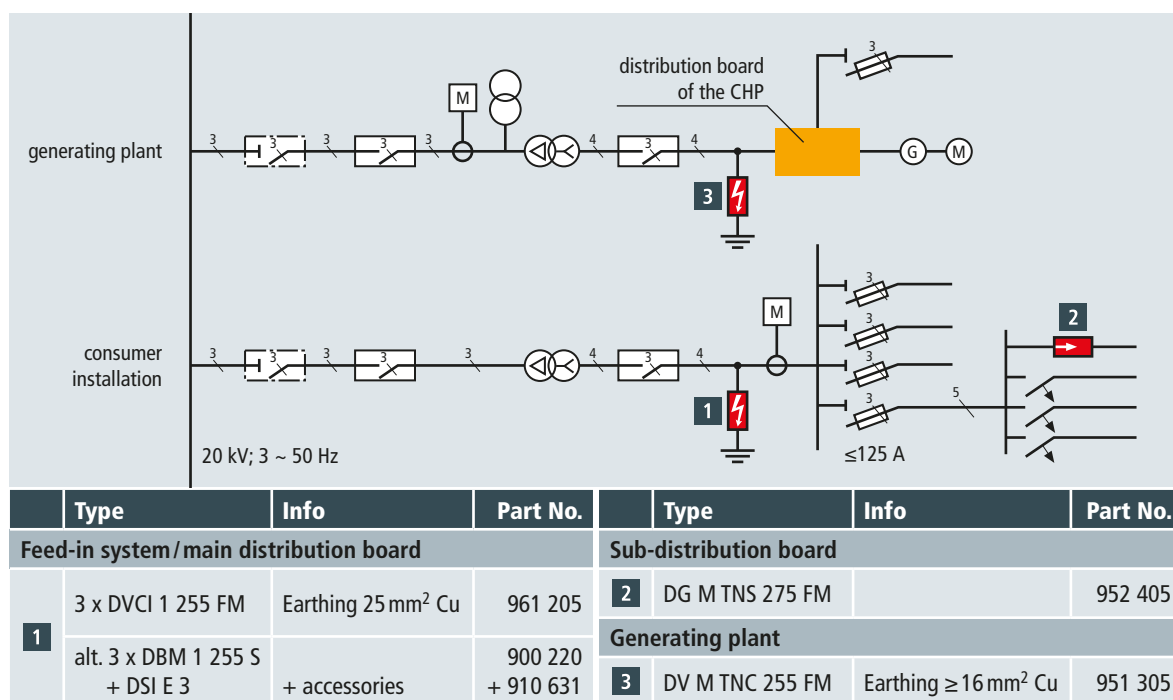

Figure 10 Excerpt from the block diagram of a biogas plant

Lightning and surge protection for biogas plants

White Paper



ample, is a type 1 surge protective device with RADAX Flow spark gaps for power supply systems. This lightning current arrester has a discharge capacity of up to 25 kA (10/350 μ s) per pole. The patented RADAX Flow principle limits and extinguishes short-circuit currents (follow currents) up to 100 kA_{rms}. This prevents unwanted power disruptions caused by tripping main fuses. Type 2 DEHNgard M TNS 275 FM surge arresters are installed in the downstream sub-distribution boards.

A modular multipole DEHNventil combined arrester with high follow current limitation is installed in the distribution board of the CHP (Figure 9.3.10). This prewired spark-gap-based combined arrester comprises a base part and plug-in protection modules. DEHNventil ensures maximum availability of the installation, disconnection selectivity with respect to 20 A gL/gG fuses as well as limitation and extinction of mains follow currents up to short-circuit currents of 100 kA_{rms}.

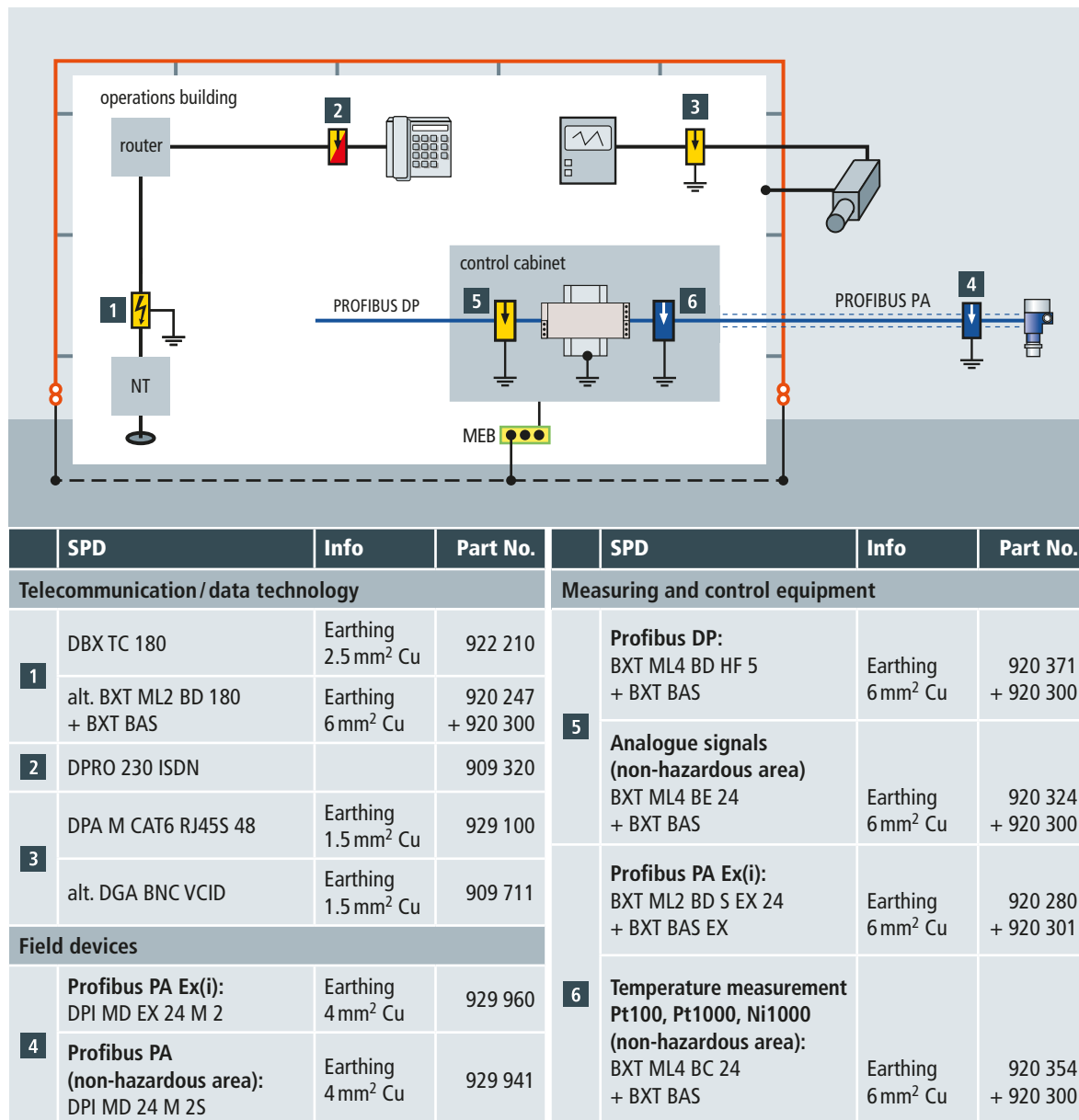

Figure 11 Surge protection for the installations of information technology systems

Lightning and surge protection for biogas plants

White Paper



Figure 12 Combined arrester modules with LifeCheck

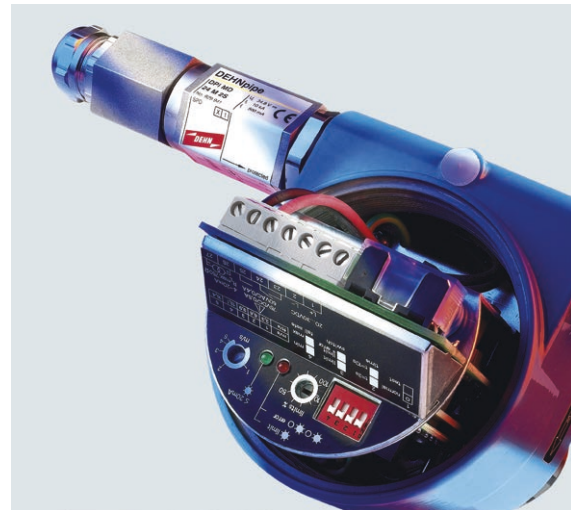

Figure 13 DEHNpipe surge arrester for outdoor use is screwed onto two-conductor field devices

If DEHNventil is installed close to the loads (≤ 5 m), protection of terminal equipment is also ensured.

Remote monitoring

The remote monitoring system ensures that the performance data of the biogas plant are permanently available. The installation-specific measured values can be directly read off the acquisition unit. This unit features interfaces such as Ethernet or RS 485 which are connected to a PC and/or modems for remote enquiry and maintenance. Remote monitoring, for example via modem, allows service staff to log on to existing systems and to provide the operator with immediate support in case of failure. It must also be ensured that the measured data are forwarded by means of the telecommunication network to provide permanent monitoring and to optimise the performance of the installation. For this purpose, the communication interface is protected by a BLITZDUCTOR XT combined arrester or a DEHNbox TC 180 (Figure 11). It is advisable to use a DEHNprotector surge arrester to protect the power and data side of terminal equipment for telecommunications and telephone systems with an RJ connection. Figure 11 shows an example of how to protect a CCTV camera by means of these arresters. The arrester DPA M CAT6 RJ45S with patch cable is used to protect the data line (data network – Ethernet). If a coaxial cable is used for video transmission, the arrester DGA BNC VCID is used.

Process control

The control unit is a key element of a biogas plant. Its function is to centrally actuate all pumps and mixers, record process data such as the gas volume and gas quality, monitor the tem-

perature and acquire all input materials as well as to visualise and document all data.

If surges cause the process control to fail, the biogas production processes will be disrupted and interrupted. Since these processes are extremely complex, unscheduled downtime could lead to additional problems causing the plant to be at a standstill for weeks.

The control unit is installed in the control cabinet. In addition to digital inputs and outputs, e.g. PT 100 signals, 4–20 mA signals or the like are evaluated here. To ensure undisturbed and permanent transmission of the measured data to the control unit in the control cabinet at all times, the control and signal lines extending beyond the buildings, for example, those of frequency converters and actuators, must be protected by installing BLITZDUCTOR XT lightning current arresters (category D1) as close as possible to the entrance point into the building (Figure 12). A contactless and fast arrester testing system (LifeCheck) is integrated in these surge protective devices. Surge protective devices for information technology systems are chosen according to the maximum continuous operating voltage, the nominal current, the type of signal (DC, LF, HF) and the type of signal transmission (balanced, unbalanced).

Figure 11 shows examples of surge protective devices for signal and control lines.

It is advisable to install a DEHNpipe surge arrester to protect two-wire field devices such as pressure or level sensors, valves, pressure transmitters or flow meters (Figure 13). This arrester ensures energy-coordinated surge protection for outdoor field devices and takes up little space.

DEHNventil

DV M TNC 255 FM (951 305)

- Prewired combined type 1 and type 2 spark-gap-based lightning current and surge arrester consisting of a base part and plug-in protection modules
- Maximum system availability due to RADAX Flow follow current limitation
- Capable of protecting terminal equipment



Figure without obligation

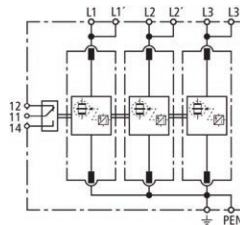

Basic circuit diagram DV M TNC 255 FM

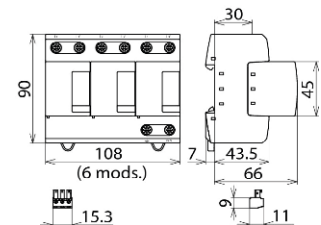

Dimension drawing DV M TNC 255 FM

Modular combined lightning current and surge arrester for TN-C systems.

Type	DV M TNC 255 FM
Part No.	951 305
SPD according to EN 61643-11 / IEC 61643-11	type 1 + type 2 / class I + class II
Energy coordination with terminal equipment (≤ 10 m)	type 1 + type 2 + type 3
Nominal voltage (a.c.) (U_N)	230 / 400 V (50 / 60 Hz)
Max. continuous operating voltage (a.c.) (U_C)	264 V (50 / 60 Hz)
Lightning impulse current (10/350 μ s) [L1+L2+L3-PEN] (I_{total})	75 kA
Specific energy [L1+L2+L3-PEN] (W/R)	1.40 MJ/ohms
Lightning impulse current (10/350 μ s) [L-PEN] (I_{imp})	25 kA
Specific energy [L-PEN] (W/R)	156.25 kJ/ohms
Nominal discharge current (8/20 μ s) [L-PEN]/[L1+L2+L3-PEN] (I_n)	25 / 75 kA
Voltage protection level (U_p)	≤ 1.5 kV
Follow current extinguishing capability (a.c.) (I_n)	50 kA _{rms}
Follow current limitation / Selectivity	no tripping of a 20 A gG fuse up to 50 kA _{rms} (prosp.)
Response time (t_A)	≤ 100 ns
Max. backup fuse (L) up to $I_k = 50$ kA _{rms}	315 A gG
Max. backup fuse (L-L')	125 A gG
Temporary overvoltage (TOV) (U_T) – Characteristic	440 V / 120 min. – withstand
Operating temperature range [parallel] / [series] (T_U)	-40 °C ... +80 °C / -40 °C ... +60 °C
Operating state / fault indication	green / red
Number of ports	1
Cross-sectional area (L1, L1', L2, L2', L3, L3', PEN, \pm) (min.)	10 mm ² solid / flexible
Cross-sectional area (L1, L2, L3, PEN) (max.)	50 mm ² stranded / 35 mm ² flexible
Cross-sectional area (L1', L2', L3', \pm) (max.)	35 mm ² stranded / 25 mm ² flexible
For mounting on	35 mm DIN rails acc. to EN 60715
Enclosure material	thermoplastic, red, UL 94 V-0
Place of installation	indoor installation
Degree of protection	IP 20
Capacity	6 module(s), DIN 43880
Approvals	KEMA, VDE, UL
Type of remote signalling contact	changeover contact
Switching capacity (a.c.)	250 V / 0.5 A
Switching capacity (d.c.)	250 V / 0.1 A; 125 V / 0.2 A; 75 V / 0.5 A
Cross-sectional area for remote signalling terminals	max. 1.5 mm ² solid / flexible
Extended technical data:	For use in switchgear installations with prospective short-circuit currents of more than 50 kA _{rms} (tested by the German VDE)
– Max. prospective short-circuit current	100 kA _{rms} (220 kA _{peak})
– Limitation / Extinction of mains follow currents	up to 100 kA _{rms} (220 kA _{peak})
– Max. backup fuse (L) up to $I_k = 100$ kA _{rms}	315 A gG
Weight	962 g
Customs tariff number (Comb. Nomenclature EU)	85363090
GTIN	4013364108141
PU	1 pc(s)

DEHNbloc Maxi

DBM 1 255 S (900 220)

- Combination of spark gap and integrated backup fuse
- For mounting directly onto the PEN / N busbar
- High follow current extinguishing capability and follow current limitation due to RADAX Flow technology



Figure without obligation

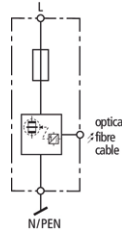

Basic circuit diagram DBM 1 255 S

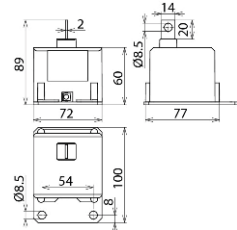

Dimension drawing DBM 1 255 S

Coordinated single-pole lightning current arrester with integrated backup fuse for busbar installation.

Type	DBM 1 255 S
Part No.	900 220
SPD according to EN 61643-11 / IEC 61643-11	type 1 / class I
Nominal voltage (a.c.) (U_N)	230 V (50 / 60 Hz)
Max. continuous operating voltage (a.c.) (U_C)	255 V (50 / 60 Hz)
Lightning impulse current (10/350 μ s) (I_{imp})	25 kA
Specific energy (W/R)	156.25 kJ/ohms
Voltage protection level (U_p)	≤ 2.5 kV (including 80 cm connecting cable)
Follow current extinguishing capability (a.c.) (I_{fc})	50 kA _{rms}
Follow current limitation / Selectivity	no tripping of a 32 A gG fuse up to 50 kA _{rms} (prosp.)
Response time (t_A)	≤ 100 ns
Short-circuit withstand capability (I_{SCCR})	100 kA _{rms} (220 kA _{peak})
Max. mains-side overcurrent protection	not required
Rated breaking capacity of the internal backup protection	100 kA
Temporary overvoltage (TOV) (U_T) – Characteristic	440 V / 120 min. – withstand
Operating temperature range (T_U)	-40 °C ... +80 °C
Number of ports	1
For mounting on	PEN / N busbars min. 35 mm ²
Connection	cable lug min. 35 mm ² / max. 50 mm ²
Enclosure material	thermoplastic, red, UL 94 V-0
Place of installation	indoor installation
Dimensions (W x H x D)	72 x 89 x 100 mm
Operating state indication	by optical fibre cables via DSI E 3
Extended technical data:	Use in switchgear installations with prospective short-circuit currents of more than 50 kA _{rms} (tested by the German VDE)
– Max. prospective short-circuit current	100 kA _{rms} (220 kA _{peak})
– Limitation / Extinction of mains follow currents	up to 100 kA _{rms} (220 kA _{peak})
Weight	699 g
Customs tariff number (Comb. Nomenclature EU)	85363090
GTIN	4013364106734
PU	1 pc(s)

DEHNvenCI

DVCI 1 255 FM (961 205)

- Spark-gap-based combined lightning current and surge arrester with integrated lightning current carrying backup fuse
- Maximum system availability due to RADAX Flow follow current limitation
- Capable of protecting terminal equipment



Figure without obligation

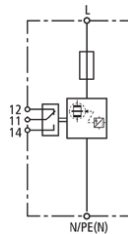

Basic circuit diagram DVCI 1 255 FM

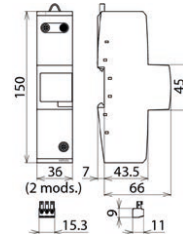

Dimension drawing DVCI 1 255 FM

Combined lightning current and surge arrester with integrated lightning current carrying backup fuse.

Type	DVCI 1 255 FM
Part No.	961 205
SPD according to EN 61643-11 / IEC 61643-11	type 1 + type 2 / class I + class II
Energy coordination with terminal equipment	type 1 + type 2
Energy coordination with terminal equipment (≤ 10 m)	type 1 + type 2 + type 3
Nominal voltage (a.c.) (U_N)	230 V (50 / 60 Hz)
Maximum continuous operating voltage (a.c.) (U_C)	255 V (50 / 60 Hz)
Lightning impulse current (10/350 μ s) (I_{imp})	25 kA
Specific energy (W/R)	156.25 kJ/ohms
Nominal discharge current (8/20 μ s) (I_n)	25 kA
Voltage protection level (U_P)	≤ 1.5 kV
Follow current extinguishing capability (a.c.) (I_f)	50 kA _{rms}
Follow current limitation / Selectivity	no tripping of a 20 A gG fuse up to 50 kA _{rms} (prosp.)
Response time (t_A)	≤ 100 ns
Max. mains-side overcurrent protection	not required
Rated breaking capacity of the internal backup protection	100 kA
Temporary overvoltage (TOV) (U_T) – Characteristic	440 V / 120 min. – withstand
Operating temperature range (T_U)	-40 °C ... +80 °C
Operating state / fault indication	green / red
Number of ports	1
Cross-sectional area (L, N/PE(N)) (min.)	10 mm ² solid / flexible
Cross-sectional area (L, N/PE(N)) (max.)	50 mm ² stranded / 35 mm ² flexible
For mounting on	35 mm DIN rails acc. to EN 60715
Enclosure material	thermoplastic, red, UL 94 V-0
Place of installation	indoor installation
Degree of protection	IP 20
Capacity	2 module(s), DIN 43880
Approvals	KEMA
Type of remote signalling contact	changeover contact
Switching capacity (a.c.)	250 V / 0.5 A
Switching capacity (d.c.)	250 V / 0.1 A; 125 V / 0.2 A; 75 V / 0.5 A
Cross-sectional area for remote signalling terminals	max. 1.5 mm ² solid / flexible
Extended technical data:	For use in switchgear installations with prospective short-circuit currents of more than 50 kA _{rms} (tested by the German VDE)
– Max. prospective short-circuit current	100 kA _{rms} (220 kA _{peak})
– Limitation / Extinction of mains follow currents	up to 100 kA _{rms} (220 kA _{peak})
Weight	435 g
Customs tariff number (Comb. Nomenclature EU)	85363090
GTIN	4013364145115
PU	1 pc(s)

DEHNguard

DG M TNS 275 FM (952 405)

- Prewired complete unit consisting of a base part and plug-in protection modules
- High discharge capacity due to heavy-duty zinc oxide varistors / spark gaps
- High reliability due to "Thermo Dynamic Control" SPD monitoring device



Figure without obligation

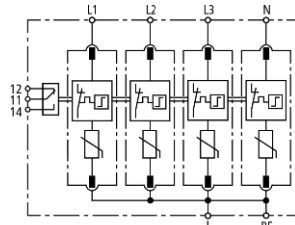

Basic circuit diagram DG M TNS 275 FM

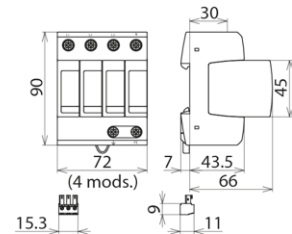

Dimension drawing DG M TNS 275 FM

Modular surge arrester for use in TN-S systems; with floating remote signalling contact.

Type	DG M TNS 275 FM
Part No.	952 405
SPD according to EN 61643-11 / IEC 61643-11	type 2 / class II
Energy coordination with terminal equipment (≤ 10 m)	type 2 + type 3
Nominal voltage (a.c.) (U_N)	230 / 400 V (50 / 60 Hz)
Max. continuous operating voltage (a.c.) (U_C)	275 V (50 / 60 Hz)
Nominal discharge current (8/20 μ s) (I_n)	20 kA
Max. discharge current (8/20 μ s) (I_{max})	40 kA
Voltage protection level [L-PE]/[N-PE] (U_P)	≤ 1.5 / ≤ 1.5 kV
Voltage protection level [L-PE] / [N-PE] at 5 kA (U_P)	≤ 1 / ≤ 1 kV
Response time (t_A)	≤ 25 ns
Max. mains-side overcurrent protection	125 A gG
Short-circuit withstand capability for max. mains-side overcurrent protection (I_{SCCR})	50 kA _{rms}
Temporary overvoltage (TOV) (U_T) – Characteristic	335 V / 5 sec. – withstand
Temporary overvoltage (TOV) (U_T) – Characteristic	440 V / 120 min. – safe failure
Operating temperature range (T_U)	-40 °C ... +80 °C
Operating state / fault indication	green / red
Number of ports	1
Cross-sectional area (min.)	1.5 mm ² solid / flexible
Cross-sectional area (max.)	35 mm ² stranded / 25 mm ² flexible
For mounting on	35 mm DIN rails acc. to EN 60715
Enclosure material	thermoplastic, red, UL 94 V-0
Place of installation	indoor installation
Degree of protection	IP 20
Capacity	4 module(s), DIN 43880
Approvals	KEMA, VDE, UL
Type of remote signalling contact	changeover contact
Switching capacity (a.c.)	250 V / 0.5 A
Switching capacity (d.c.)	250 V / 0.1 A; 125 V / 0.2 A; 75 V / 0.5 A
Cross-sectional area for remote signalling terminals	max. 1.5 mm ² solid / flexible
Weight	453 g
Customs tariff number (Comb. Nomenclature EU)	85363030
GTIN	4013364108462
PU	1 pc(s)

DEHNsignal

DSI E 3 (910 631)

- Operating state indication of the connected surge protective device
- Floating changeover contact
- Selective operating state indication



Figure without obligation

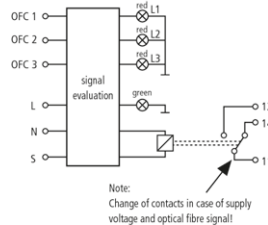

Basic circuit diagram DSI E 3

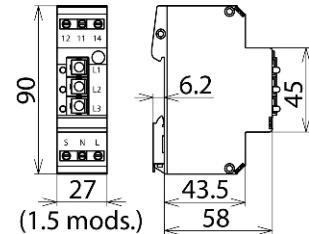

Dimension drawing DSI E 3

Receiver module for optical transmission for selective operating state indication / centralised fault indication of three coordinated DEHNbloc Maxi S and, where appropriate, DEHNgap Maxi S lightning current arresters in five-wire systems.

Type Part No.	DSI E 3 910 631
Supply voltage (a.c.) (U_N)	230 V
Power input (P)	< 550 mW
Backup fuse for supply voltage	16 A gG or C 16 A
Operating temperature range (T_U)	-40 °C ... +80 °C
Signal input	3x via optical fibre plug-in system (LWL ST DSI)
Operating state indication	green LED
Selective operating state indication	3x red LEDs (L1, L2, L3)
For mounting on	35 mm DIN rails acc. to EN 60715
Enclosure material	thermoplastic, red, UL 94 V-0
Degree of protection	IP 20
Capacity	1.5 module(s), DIN 43880
Type of remote signalling contact	floating changeover contact
Switching capacity (a.c.)	250 V / 0.5 A
Switching capacity (d.c.)	250 V / 0.1 A; 125 V / 0.2 A; 75 V / 0.5 A
Cross-sectional area (min.)	0.5 mm ² solid / flexible
Cross-sectional area (max.)	4 mm ² solid / flexible
Max. distance with LWL DSI 18M	6 m
Test standards	EN 61010-1:1993 and EN 61010-1/A2:1995
Weight	114 g
Customs tariff number (Comb. Nomenclature EU)	85389091
GTIN	4013364108196
PU	1 pc(s)

DEHNbox

DBX TC 180 (922 210)

- Powerful protection for telecommunication interfaces
- Suitable for wall mounting, IP 65
- Installation in conformity with the lightning protection zone concept at the boundaries from $0_A - 2$ and higher



Figure without obligation

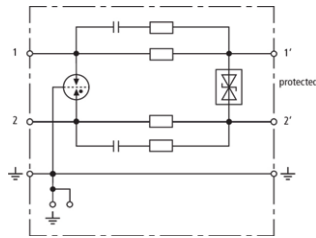

Basic circuit diagram DBX TC 180

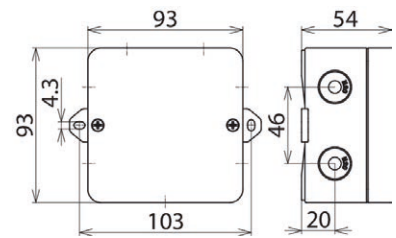

Dimension drawing DBX TC 180

Compact combined arrester in a surface-mounted plastic enclosure for protecting information technology interfaces, particularly telecommunication connections and devices such as analogue telephones, ISDN and xDSL (VDSL2-tested). Fast connection of one pair without tools and integrated strain relief for the connecting cable. Cut-off frequency up to 250 MHz ensures maximum transmission performance in case of high-frequency signal parts.

Type	DBX TC 180
Part No.	922 210
SPD class	TYPE 1P2
Nominal voltage (U_N)	180 V
Max. continuous operating voltage (d.c.) (U_C)	180 V
Max. continuous operating voltage (a.c.) (U_C)	127 V
Nominal current at 45°C (I_L)	0.75 A
D1 Total lightning impulse current (10/350 μ s) (I_{imp})	7.5 kA
D1 Lightning impulse current (10/350 μ s) per line (I_{imp})	2.5 kA
C2 Total nominal discharge current (8/20 μ s) (I_n)	15 kA
C2 Nominal discharge current (8/20 μ s) per line (I_n)	7.5 kA
Voltage protection level line-line at 1 kV/ μ s C3 (U_p)	≤ 250 V
Voltage protection level line-PG at 1 kV/ μ s C3 (U_p)	≤ 550 V
Voltage protection level line-line for I_{imp} D1 (U_p)	≤ 300 V
Voltage protection level line-PG for I_{imp} D1 (U_p)	≤ 550 V
Series resistance per line	1.8 ohms
Bandwidth line-line (100 ohms) (f_c)	250 MHz
Capacitance line-line (C)	≤ 20 pF
Capacitance line-PG (C)	≤ 10 pF
Operating temperature range (T_U)	-25 °C ... +40 °C
Degree of protection	IP 65
Cross-sectional area of the signal lines, solid	0.2-1.5 mm ²
Cross-sectional area of the signal lines, flexible	0.25-1.5 mm ²
Cross-sectional area of the earth terminal	0.25-2.5 mm ²
Dimensions (L x W x H)	93 x 93 x 55 mm
Enclosure material	polycarbonate
Colour	grey
Test standards	IEC 61643-21 / EN 61643-21
Weight	138 g
Customs tariff number (Comb. Nomenclature EU)	85363010
GTIN	4013364158214
PU	1 pc(s)

BLITZDUCTOR XT

BXT ML2 BD 180 (920 247)

- LifeCheck SPD monitoring function
- Optimal protection of one pair
- For installation in conformity with the lightning protection zone concept at the boundaries from $0_A - 2$ and higher



Figure without obligation

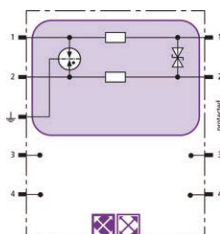

Basic circuit diagram BXT ML2 BD 180

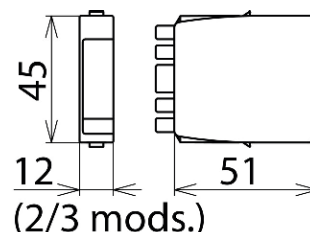

Dimension drawing BXT ML2 BD 180

Space-saving combined lightning current and surge arrester module with LifeCheck feature for protecting one pair of unearthed balanced interfaces. If LifeCheck detects thermal or electrical overload, the arrester has to be replaced. This status is indicated contactlessly by the DEHNrecord LC / SCM / MCM reader.

Type	BXT ML2 BD 180
Part No.	920 247
SPD monitoring system	LifeCheck
SPD class	TYPE 1P2
Nominal voltage (U_N)	180 V
Max. continuous operating voltage (d.c.) (U_c)	180 V
Max. continuous operating voltage (a.c.) (U_c)	127 V
Nominal current at 45 °C (I_L)	0.75 A
D1 Total lightning impulse current (10/350 μ s) (I_{imp})	5 kA
D1 Lightning impulse current (10/350 μ s) per line (I_{imp})	2.5 kA
C2 Total nominal discharge current (8/20 μ s) (I_n)	20 kA
C2 Nominal discharge current (8/20 μ s) per line (I_n)	10 kA
Voltage protection level line-line for I_{imp} D1 (U_p)	≤ 270 V
Voltage protection level line-PG for I_{imp} D1 (U_p)	≤ 550 V
Voltage protection level line-line at 1 kV/ μ s C3 (U_p)	≤ 250 V
Voltage protection level line-PG at 1 kV/ μ s C3 (U_p)	≤ 550 V
Series resistance per line	1.8 ohm(s)
Cut-off frequency line-line (f_c)	25.0 MHz
Capacitance line-line (C)	≤ 240 pF
Capacitance line-PG (C)	≤ 16 pF
Operating temperature range (T_U)	-40 °C ... +80 °C
Degree of protection (with plugged-in protection module)	IP 20
Pluggable into	BXT BAS / BSP BAS 4 base part
Earthing via	BXT BAS / BSP BAS 4 base part
Enclosure material	polyamide PA 6.6
Colour	yellow
Test standards	IEC 61643-21 / EN 61643-21, UL 497B
Approvals	CSA, EAC, ATEX, IECEx, CSA & USA Hazloc, SIL
SIL classification	up to SIL3 ^{*)}
ATEX approvals	DEKRA 11ATEX0089 X: II 3 G Ex nA IIC T4 Gc
IECEx approvals	DEK 11.0032X: Ex nA IIC T4 Gc
CSA & USA Hazloc approvals (1)	2516389: Class I Div. 2 GP A, B, C, D T4
CSA & USA Hazloc approvals (2)	2516389: Class I Zone 2, AEx nA IIC T4
Weight	43 g
Customs tariff number (Comb. Nomenclature EU)	85363010
GTIN	4013364116078
PU	1 pc(s)

^{*)} For more detailed information, please visit www.dehn-international.com.

BLITZDUCTOR XT

BXT ML4 BE 24 (920 324)

- LifeCheck SPD monitoring function
- Optimal protection of four single lines
- For installation in conformity with the lightning protection zone concept at the boundaries from $0_A - 2$ and higher



Figure without obligation

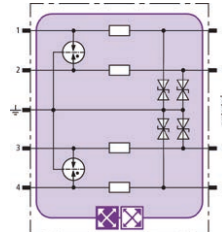

Basic circuit diagram BXT ML4 BE 24

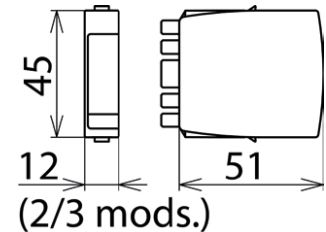

Dimension drawing BXT ML4 BE 24

Space-saving combined lightning current and surge arrester module with LifeCheck feature for protecting four single lines sharing a common reference potential as well as unbalanced interfaces. If LifeCheck detects thermal or electrical overload, the arrester has to be replaced. This status is indicated contactlessly by the DEHNrecord LC / SCM / MCM reader.

Type	BXT ML4 BE 24
Part No.	920 324
SPD monitoring system	LifeCheck
SPD class	TYPE 1 PE
Nominal voltage (U_N)	24 V
Max. continuous operating voltage (d.c.) (U_c)	33 V
Max. continuous operating voltage (a.c.) (U_c)	23.3 V
Nominal current at 45 °C (I_L)	0.75 A
D1 Total lightning impulse current (10/350 μ s) (I_{imp})	10 kA
D1 Lightning impulse current (10/350 μ s) per line (I_{imp})	2.5 kA
C2 Total nominal discharge current (8/20 μ s) (I_n)	20 kA
C2 Nominal discharge current (8/20 μ s) per line (I_n)	10 kA
Voltage protection level line-line for I_{imp} D1 (U_p)	≤ 102 V
Voltage protection level line-PG for I_{imp} D1 (U_p)	≤ 66 V
Voltage protection level line-line at 1 kV/ μ s C3 (U_p)	≤ 90 V
Voltage protection level line-PG at 1 kV/ μ s C3 (U_p)	≤ 45 V
Series resistance per line	1.8 ohm(s)
Cut-off frequency line-PG (f_c)	6.8 MHz
Capacitance line-line (C)	≤ 0.5 nF
Capacitance line-PG (C)	≤ 1.0 nF
Operating temperature range (T_U)	-40 °C ... +80 °C
Degree of protection (with plugged-in protection module)	IP 20
Pluggable into	BXT BAS / BSP BAS 4 base part
Earthing via	BXT BAS / BSP BAS 4 base part
Enclosure material	polyamide PA 6.6
Colour	yellow
Test standards	IEC 61643-21 / EN 61643-21, UL 497B
Approvals	CSA, UL, EAC, ATEX, IECEx, CSA & USA Hazloc, SIL
SIL classification	up to SIL3 ^{*)}
ATEX approvals	DEKRA 11ATEX0089 X: II 3 G Ex nA IIC T4 Gc
IECEx approvals	DEK 11.0032X: Ex nA IIC T4 Gc
CSA & USA Hazloc approvals (1)	2516389: Class I Div. 2 GP A, B, C, D T4
CSA & USA Hazloc approvals (2)	2516389: Class I Zone 2, AEx nA IIC T4
Weight	38 g
Customs tariff number (Comb. Nomenclature EU)	85363010
GTIN	4013364109056
PU	1 pc(s)

^{*)} For more detailed information, please visit www.dehn-international.com.

BLITZDUCTOR XT

BXT ML4 BC 24 (920 354)

- LifeCheck SPD monitoring function
- Optimal protection of max. four lines
- For installation in conformity with the lightning protection zone concept at the boundaries from 0_{A-2} and higher



Figure without obligation

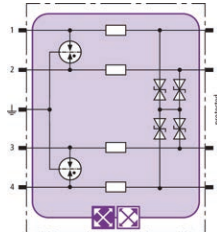

Basic circuit diagram BXT ML4 BC 24

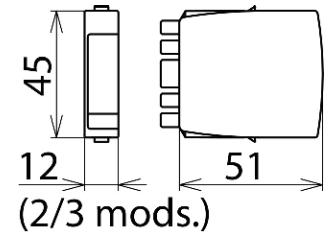

Dimension drawing BXT ML4 BC 24

Space-saving combined lightning current and surge arrester module with LifeCheck feature for protecting max. four unearthed single lines with common reference potential. If LifeCheck detects thermal or electrical overload, the arrester has to be replaced. This status is indicated contactlessly by the DEHNrecord LC / SCM / MCM reader.

Type	BXT ML4 BC 24
Part No.	920 354
SPD monitoring system	LifeCheck
SPD class	TYPE 1 PC
Nominal voltage (U_N)	24 V
Max. continuous operating voltage (d.c.) (U_c)	33 V
Max. continuous operating voltage (a.c.) (U_c)	23.3 V
Nominal current at 45 °C (I_L)	0.75 A
D1 Total lightning impulse current (10/350 μ s) (I_{imp})	10 kA
D1 Lightning impulse current (10/350 μ s) per line (I_{imp})	2.5 kA
C2 Total nominal discharge current (8/20 μ s) (I_n)	20 kA
C2 Nominal discharge current (8/20 μ s) per line (I_n)	10 kA
Voltage protection level line-line for I_{imp} D1 (U_p)	≤ 55 V
Voltage protection level line-PG for I_{imp} D1 (U_p)	≤ 550 V
Voltage protection level line-line at 1 kV/ μ s C3 (U_p)	≤ 45 V
Voltage protection level line-PG at 1 kV/ μ s C3 (U_p)	≤ 550 V
Series resistance per line	1.8 ohm(s)
Cut-off frequency line-line (f_c)	5.7 MHz
Capacitance line-line (C)	≤ 1.0 nF
Capacitance line-PG (C)	≤ 16 pF
Operating temperature range (T_U)	-40 °C ... +80 °C
Degree of protection (with plugged-in protection module)	IP 20
Pluggable into	BXT BAS / BSP BAS 4 base part
Earthing via	BXT BAS / BSP BAS 4 base part
Enclosure material	polyamide PA 6.6
Colour	yellow
Test standards	IEC 61643-21 / EN 61643-21, UL 497B
Approvals	CSA, EAC, ATEX, IECEx, CSA & USA Hazloc, SIL
SIL classification	up to SIL3 ^{*)}
ATEX approvals	DEKRA 11ATEX0089 X: II 3 G Ex nA IIC T4 Gc
IECEx approvals	DEK 11.0032X: Ex nA IIC T4 Gc
CSA & USA Hazloc approvals (1)	2516389: Class I Div. 2 GP A, B, C, D T4
CSA & USA Hazloc approvals (2)	2516389: Class I Zone 2, AEx nA IIC T4
Weight	24 g
Customs tariff number (Comb. Nomenclature EU)	85363010
GTIN	4013364109148
PU	1 pc(s)

^{*)} For more detailed information, please visit www.dehn-international.com.

BLITZDUCTOR XT

BXT ML4 BD HF 5 (920 371)

- LifeCheck SPD monitoring function
- Minimal signal interference
- For installation in conformity with the lightning protection zone concept at the boundaries from $0_A -2$ and higher



Figure without obligation

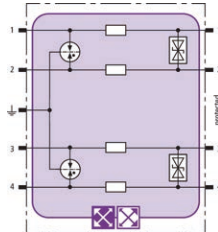

Basic circuit diagram BXT ML4 BD HF 5

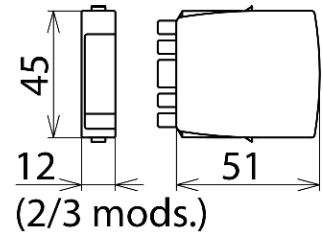

Dimension drawing BXT ML4 BD HF 5

Space-saving combined lightning current and surge arrester module with LifeCheck feature for protecting two pairs of high-frequency bus systems or video transmission systems. If LifeCheck detects thermal or electrical overload, the arrester has to be replaced. This status is indicated contactlessly by the DEHNrecord LC / SCM / MCM reader.

Type	BXT ML4 BD HF 5
Part No.	920 371
SPD monitoring system	LifeCheck
SPD class	TYPE 1 PD
Nominal voltage (U_N)	5 V
Max. continuous operating voltage (d.c.) (U_c)	6.0 V
Max. continuous operating voltage (a.c.) (U_c)	4.2 V
Nominal current at 45 °C (I_L)	1.0 A
D1 Total lightning impulse current (10/350 μ s) (I_{imp})	10 kA
D1 Lightning impulse current (10/350 μ s) per line (I_{imp})	2.5 kA
C2 Total nominal discharge current (8/20 μ s) (I_n)	20 kA
C2 Nominal discharge current (8/20 μ s) per line (I_n)	10 kA
Voltage protection level line-line for I_{imp} D1 (U_p)	≤ 25 V
Voltage protection level line-PG for I_{imp} D1 (U_p)	≤ 550 V
Voltage protection level line-line at 1 kV/ μ s C3 (U_p)	≤ 11 V
Voltage protection level line-PG at 1 kV/ μ s C3 (U_p)	≤ 550 V
Series resistance per line	1.0 ohm(s)
Cut-off frequency line-line (f_c)	100.0 MHz
Capacitance line-line (C)	≤ 25 pF
Capacitance line-PG (C)	≤ 16 pF
Operating temperature range (T_U)	-40 °C ... +80 °C
Degree of protection (with plugged-in protection module)	IP 20
Pluggable into	BXT BAS / BSP BAS 4 base part
Earthing via	BXT BAS / BSP BAS 4 base part
Enclosure material	polyamide PA 6.6
Colour	yellow
Test standards	IEC 61643-21 / EN 61643-21, UL 497B
Approvals	CSA, UL, EAC, ATEX, IECEx, CSA & USA Hazloc, SIL
SIL classification	up to SIL3 [*]
ATEX approvals	DEKRA 11ATEX0089 X: II 3 G Ex nA IIC T4 Gc
IECEx approvals	DEK 11.0032X: Ex nA IIC T4 Gc
CSA & USA Hazloc approvals (1)	2516389: Class I Div. 2 GP A, B, C, D T4
CSA & USA Hazloc approvals (2)	2516389: Class I Zone 2, AEx nA IIC T4
Weight	24 g
Customs tariff number (Comb. Nomenclature EU)	85363010
GTIN	4013364109094
PU	1 pc(s)

^{*}For more detailed information, please visit www.dehn-international.com.

BLITZDUCTOR XT

BXT ML2 BD S EX 24 (920 280)

- For universal use, with LifeCheck monitoring function
- Self-capacitance and self-inductance negligibly small
- For installation in conformity with the lightning protection zone concept at the boundaries from 0_B-2 and higher



Figure without obligation

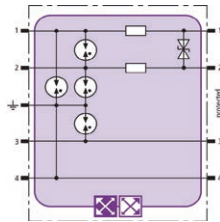

Basic circuit diagram BXT ML2 BD S EX 24

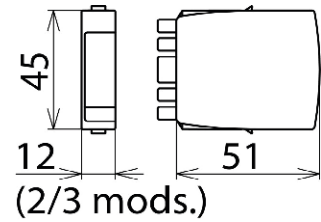

Dimension drawing BXT ML2 BD S EX 24

Space-saving LifeCheck-equipped surge arrester module for protecting one pair in intrinsically safe measuring circuits and bus systems, direct or indirect shield earthing. Insulation strength > 500 V line-earth.

If LifeCheck detects thermal or electrical overload, the arrester has to be replaced. This status is indicated contactlessly by DEHNrecord LC / SCM / MCM.

Type	BXT ML2 BD S EX 24
Part No.	920 280
SPD class	TYPE 2 Pt
SPD monitoring	LifeCheck
Nominal voltage (U_N)	24 V
Max. continuous operating voltage (d.c.) (U_c)	33 V
Max. continuous operating voltage (a.c.) (U_c)	23.3 V
Max. input voltage acc. to EN 60079-11 (U_i)	30 V
Max. input current acc. to EN 60079-11 (I_i)	0.5 A
D1 Total lightning impulse current (10/350 μ s) (I_{imp})	4 kA
D1 Lightning impulse current (10/350 μ s) per line (I_{imp})	1 kA
C2 Total nominal discharge current (8/20 μ s) (I_n)	10 kA
C2 Nominal discharge current (8/20 μ s) per line (I_n)	5 kA
Voltage protection level line-line for I_{imp} D1 (U_p)	≤ 50 V
Voltage protection level line-PG for I_{imp} D1 (U_p)	≤ 1300 V
Voltage protection level line-line for I_n C2 (U_p)	≤ 52 V
Voltage protection level line-PG for I_n C2 (U_p)	≤ 1400 V
Voltage protection level line-line at 1 kV/ μ s C3 (U_p)	≤ 45 V
Voltage protection level line-PG at 1 kV/ μ s C3 (U_p)	≤ 1100 V
Series resistance per line	1.0 ohm
Cut-off frequency line-line (f_c)	6 MHz
Capacitance line-line (C)	≤ 1.0 nF
Capacitance line-PG (C)	≤ 16 pF
Operating temperature range (T_U)	-40 °C ... +80 °C
Degree of protection (with plugged-in protection module)	IP 20
Plugs into	base part
Earthing via	base part
Enclosure material	polyamide PA 6.6
Colour	blue
Test standards	IEC 61643-21 / EN 61643-21
Approvals ^{*)}	EACEx, ATEX, IECEx, CSA & USA Hazloc, SIL, Inmetro
ATEX approvals (1)	KEMA 06ATEX0274 X: II 2 (1) G Ex ia [ia Ga] IIC T4 ... T6 Gb
ATEX approvals (2)	KEMA 06ATEX0274 X: II 2 G Ex ib IIC T4 ... T6 Gb
IECEx approvals (1)	DEK 11.0078X: Ex ia [ia Ga] IIC T4 ... T6 Gb
IECEx approvals (2)	DEK 11.0078X: Ex ib IIC T4 ... T6 Gb
CSA & USA Hazloc approvals (1)	70000011: Class I Div. 1; Class I Zone 1
CSA & USA Hazloc approvals (2)	70000011: Ex ia [ia] IIC T4 ... T6
Inmetro approvals	TÜV 17.0697 X: Ex ia [ia Ga] IIC T6 ... T4 Gb
Weight	22 g
Customs tariff number (Comb. Nomenclature EU)	85363010
GTIN	4013364142138
PU	1 pc(s)

*) For details see: www.dehn-international.com

BLITZDUCTOR XT

BXT BAS (920 300)

- Four-pole version for universal use with all types of BSP and BXT / BXTU protection modules
- No signal interruption if the protection module is removed
- Universal design without protection elements



Figure without obligation

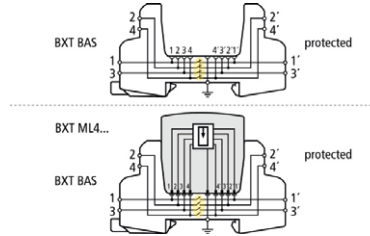

Basic circuit diagram with and without plugged-in module

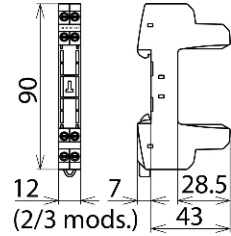

Dimension drawing BXT BAS

The BLITZDUCTOR XT base part is an extremely space-saving and universal four-pole feed-through terminal for the insertion of a protection module without signal disconnection if the protection module is removed. The snap-in mechanism at the supporting foot of the base part allows the protection module to be safely earthed via the DIN rail. Since no components of the protective circuit are situated in the base part, maintenance is only required for the protection modules.

Type Part No.	BXT BAS 920 300
Operating temperature range (T _U)	-40 °C ... +80 °C
Degree of protection	IP 20
For mounting on	35 mm DIN rails acc. to EN 60715
Connection (input / output)	screw / screw
Signal disconnection	no
Cross-sectional area, solid	0.08-4 mm ²
Cross-sectional area, flexible	0.08-2.5 mm ²
Tightening torque (terminals)	0.4 Nm
Earthing via	35 mm DIN rails acc. to EN 60715
Enclosure material	polyamide PA 6.6
Colour	yellow
ATEX approvals	DEKRA 11ATEX0089 X: II 3 G Ex nA IIC T4 Gc ^{*)}
IECEX approvals	DEK 11.0032X: Ex nA IIC T4 Gc ^{*)}
Approvals	CSA, UL, EAC, ATEX, IECEX ^{*)}
Weight	34 g
Customs tariff number (Comb. Nomenclature EU)	85369010
GTIN	4013364109179
PU	1 pc(s)

^{*)} only in connection with an approved protection module

BLITZDUCTOR XT

BXT BAS EX (920 301)

- Four-pole and universal base part for all types of intrinsically safe protection modules
- No signal interruption if the protection module is removed
- Universal design without protection elements



Figure without obligation

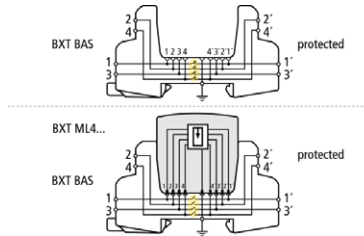

Basic circuit diagram with and without module

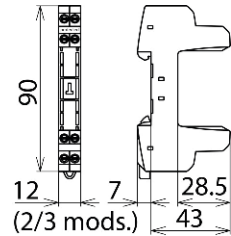

Dimension drawing BXT BAS EX

BLITZDUCTOR XT base part for use as an extremely space-saving and universal four-pole feed-through terminal for intrinsically safe circuits for the insertion of the protection module, no signal disconnection if the protection module is removed. The snap-in mechanism at the supporting foot of the base part allows the device to be safely earthed via the DIN rail. Since no components of the protective circuit are situated in the base part, only the protection modules must be maintained.

Type Part No.	BXT BAS EX 920 301
Operating temperature range	-40 °C ... +80 °C
Degree of protection	IP 20
For mounting on	35 mm DINs rails acc. to EN 60715
Connection (input / output)	screw / screw
Cross-sectional area, solid	0.08-4 mm ²
Cross-sectional area, flexible	0.08-2.5 mm ²
Tightening torque (terminals)	0.4 Nm
Earthing via	35 mm DIN rails acc. to EN 60715
Enclosure material	polyamide PA 6.6
Colour	blue
ATEX approvals (1)	KEMA 06ATEX0274 X: II 2 (1) G Ex ia [ia Ga] IIC T4 ... T6 Gb *)
ATEX approvals (2)	KEMA 06ATEX0274 X: II 2 G Ex ib IIC T4 ... T6, Gb *)
IECEX approvals (1)	DEK 11.0078X: Ex ia [ia Ga] IIC T4 ... T6 Gb *)
IECEX approvals (2)	DEK 11.0078X: Ex ib IIC T4 ... T6 Gb *)
CSA & USA Hazloc approvals (1)	70000011: Class I Div. 1; Class I Zone 1
CSA & USA Hazloc approvals (2)	70000011: Ex ia [ia] IIC T4 ... T6
Inmetro approvals	TÜV 17.0697 X: Ex ia [ia Ga] IIC T6 ... T4 Gb
Approvals	UL, CSA, EACEx, ATEX, IECEx, Inmetro *)
Weight	53 g
Customs tariff number (Comb. Nomenclature EU)	85369010
GTIN	4013364109186
PU	1 pc(s)

*) only in connection with an approved protection module

DEHNpatch

DPA M CAT6 RJ45S 48 (929 100)

- Ideally suited for retrofitting, protection of all lines
- CAT 6A in the channel according to ANSI/TIA/EIA-568
- Power over Ethernet IEEE 802.3 compliant (up to PoE++ / 4PPoE)
- For installation in conformity with the lightning protection zone concept at the boundaries from $0_b -2$ and higher



Figure without obligation

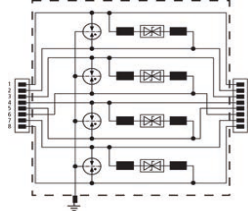

Basic circuit diagram DPA M CAT6 RJ45S 48

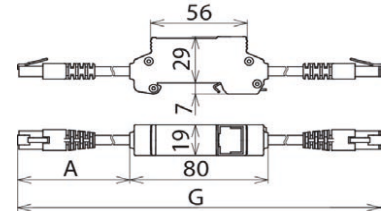

Dimension drawing DPA M CAT6 RJ45S 48

Universal arrester for Industrial Ethernet, Power over Ethernet (IEEE 802.3 compliant up to PoE++ / 4PPoE) and similar applications in structured cabling systems according to Cat. 6 and class E_A up to 500 MHz. Fully shielded type for DIN rail mounting.

Type	DPA M CAT6 RJ45S 48
Part No.	929 100
SPD class	TYPE 2 Pt
Nominal voltage (U _N)	48 V
Max. continuous operating voltage (d.c.) (U _c)	48 V
Max. continuous operating voltage (a.c.) (U _c)	34 V
Max. continuous operating voltage (d.c.) pair-pair (PoE) (U _c)	57 V
Nominal current (I _N)	1 A
D1 Lightning impulse current (10/350 μs) per line (I _{imp})	1 kA
C2 Nominal discharge current (8/20 μs) line-line (I _n)	150 A
C2 Nominal discharge current (8/20 μs) line-PG (I _n)	2.5 kA
C2 Nominal discharge current (8/20 μs) total (I _n)	10 kA
C2 Nominal discharge current (8/20 μs) pair-pair (PoE) (I _n)	150 A
Voltage protection level line-line for I _n C2 (U _p)	≤ 190 V
Voltage protection level line-PG for I _n C2 (U _p)	≤ 600 V
Voltage protection level line-line for I _n C2 (PoE) (U _p)	≤ 600 V
Voltage protection level line-line at 1 kV/μs C3 (U _p)	≤ 145 V
Voltage protection level line-PG at 1 kV/μs C3 (U _p)	≤ 500 V
Voltage protection level pair-pair at 1 kV/μs C3 (PoE) (U _p)	≤ 600 V
Cut-off frequency (f _c)	250 MHz
Insertion loss at 250 MHz	≤ 2 dB
Capacitance line-line (C)	≤ 165 pF
Capacitance line-PG (C)	≤ 255 pF
Operating temperature range (T _U)	-20 °C ... +60 °C
Degree of protection	IP 20
For mounting on	35 mm DIN rails acc. to EN 60715
Connection (input / output)	RJ45 connecting line / RJ45 connecting line
Pinning	1/2, 3/6, 4/5, 7/8
Connecting line	A = approx. 0.5 m, G = approx. 3 m
Connector	Stewart 39 series
Earthing via	35 mm DIN rail acc. to EN 60715
Enclosure material	zinc die-casting
Colour	bare surface
Test standards	IEC 61643-21 / EN 61643-21
Approvals	GHMT, EAC
Transmission class according to ISO/IEC 11801	Cat. 6
Transmission class according to EN 50173-1	Class E _A
Transmission class according to ANSI/TIA/EIA-568	cat. 6A in the channel
External accessories	fixing material
Weight	244 g
Customs tariff number (Comb. Nomenclature EU)	85363010
GTIN	4013364102170
PU	1 pc(s)

DEHNgate

DGA BNC VCID (909 711)

- Easily adaptable due to BNC sockets
- Available with direct or indirect shield earthing according to type
- For installation in conformity with the lightning protection zone concept at the boundaries from $0_B \dots 2$ and higher



Figure without obligation

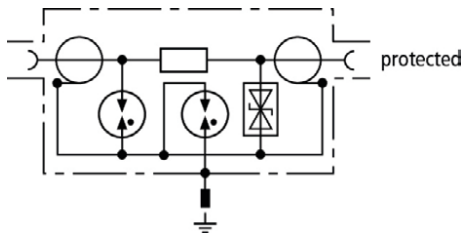

Basic circuit diagram DGA BNC VCID

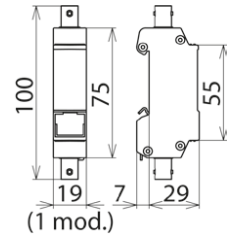

Dimension drawing DGA BNC VCID

Type	DGA BNC VCID
Part No.	909 711
SPD class	TYPE 2 Pt
Nominal voltage (U_N)	5 V
Max. continuous operating voltage (d.c.) (U_c)	6.4 V
Nominal current (I_n)	0.1 A
D1 Lightning impulse current (10/350 μ s) (I_{imp})	1 kA
C2 Nominal discharge current (8/20 μ s) shield-PG (I_n)	10 kA
C2 Nominal discharge current (8/20 μ s) line-shield (I_n)	5 kA
Voltage protection level line-shield for I_n C2 (U_p)	≤ 35 V
Voltage protection level shield-PG for I_n C2 (U_p)	≤ 650 V
Voltage protection level line-shield at 1 kV/ μ s C3 (U_p)	≤ 13 V
Voltage protection level shield-PG at 1 kV/ μ s C3 (U_p)	≤ 600 V
Frequency range	0-300 MHz
Insertion loss at 160 MHz	≤ 0.4 dB
Insertion loss at 300 MHz	≤ 3 dB
Return loss at 130 MHz	≥ 20 dB
Return loss at 300 MHz	≥ 10 dB
Characteristic impedance (Z)	50 ohms
Series resistance per line	4.7 ohms
Capacitance line-shield (C)	≤ 25 pF
Capacitance shield-PG (C)	≤ 20 pF
Operating temperature range (T_u)	-40 °C ... +80 °C
Degree of protection	IP 10
For mounting on	35 mm DIN rails according to EN 60715
Connection (input / output)	BNC socket / BNC socket
Earthing via	35 mm DIN rail according to EN 60715
Enclosure material	zinc die-casting
Colour	bare surface
Test standards	IEC 61643-21 / EN 61643-21
Approvals	CSA, UL
Weight	116 g
Customs tariff number (Comb. Nomenclature EU)	85366910
GTIN	4013364118980
PU	1 pc(s)

DEHNpipe

DPI MD 24 M 2S (929 941)

- Easy to mount due to two-part design
- Suitable for three shielding concepts
- For installation in conformity with the lightning protection zone concept at the boundaries from $0_b -2$ and higher



Figure without obligation

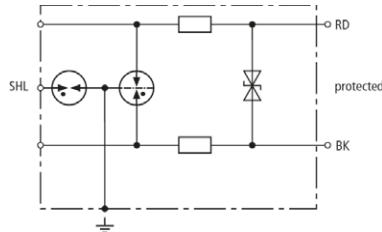

Basic circuit diagram DPI MD 24 M 2S

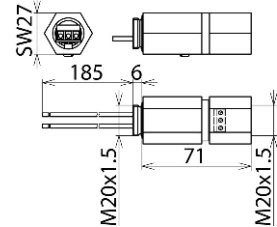

Dimension drawing DPI MD 24 M 2S

Energy-coordinated two-stage arrester, no leakage currents to earth, for 4-20 mA interfaces with thread M20 x 1.5 (female/male). Direct, indirect or no shield earthing. Cable gland available as accessory part.

Technical data

Type	DPI MD 24 M 2S
Part No.	929 941
SPD class	TYPE 2 P1
Nominal voltage (U_N)	24 V
Max. continuous operating voltage (d.c.) (U_C)	34.8 V
Max. continuous operating voltage (a.c.) (U_C)	24.5 V
Nominal current (I_N)	0.5 A
D1 Lightning impulse current (10/350 μ s) per line (I_{imp})	1 kA
C2 Total nominal discharge current (8/20 μ s) (I_n)	10 kA
C2 Nominal discharge current (8/20 μ s) per line (I_n)	10 kA
C2 Nominal discharge current (8/20 μ s) shield-PG (I_n)	20 kA
Voltage protection level line-line for I_n C2 (U_p)	≤ 65 V
Voltage protection level line-PG for I_n C2 (U_p)	≤ 650 V
Voltage protection level shield-PG for I_n C2 (U_p)	≤ 650 V
Voltage protection level line-line at 1 kV/ μ s C3 (U_p)	≤ 50 V
Voltage protection level line-PG at 1 kV/ μ s C3 (U_p)	≤ 500 V
Voltage protection level shield-PG at 1 kV/ μ s C3 (U_p)	≤ 600 V
Cut-off frequency line-line (f_c)	14 MHz
Capacitance line-line (C)	≤ 400 pF
Capacitance line-PG (C)	≤ 20 pF
Capacitance shield-PG (C)	≤ 15 pF
Series resistance per line	2.2 ohms
Operating temperature range (T_u)	-40 °C ... +80 °C
Degree of protection with cable gland	IP 67
For mounting on (field / device side)	M20 x 1.5 female thread / M20 x 1.5 male thread
Connection (input / output)	screw / connecting lines (1.5 mm ²)
Length of the connecting lead	200 mm
Cross-sectional area, solid	0.08-2.5 mm ²
Cross-sectional area, flexible	0.08-1.5 mm ²
Earthing via	enclosure or earthing ring (accessories)
Enclosure material	StSt (V2A)
Colour	bare surface
Test standards	IEC 61643-21 / EN 61643-21
Approvals	EAC, SIL
SIL classification	up to SIL3 ^{*)}
Weight	173 g
Customs tariff number (Comb. Nomenclature EU)	85363010
GTIN	4013364098152
PU	1 pc(s)

^{*)} For details see: www.dehn-international.com

DEHNpipe

DPI MD EX 24 M 2 (929 960)

- Easy to mount due to two-part design
- Self-capacitance and self-inductance negligibly small
- For installation in conformity with the lightning protection zone concept at the boundaries from $O_B - 2$ and higher



Figure without obligation

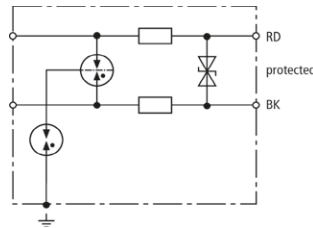

Basic circuit diagram DPI MD EX 24 M 2

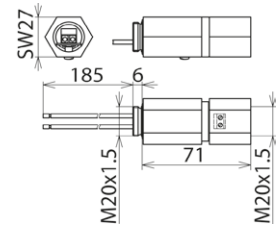

Dimension drawing DPI MD EX 24 M 2

Energy-coordinated two-stage surge arrester with low-capacitance protective circuit for protecting intrinsically safe measuring circuits and bus systems, meets FISCO requirements. Insulation strength > 500 V to earth. Cable glands must be ordered separately.

Technical data

Type	DPI MD EX 24 M 2
Part No.	929 960
SPD class	TYPE 2/PI
Nominal voltage (U_N)	24 V
Max. continuous operating voltage (d.c.) (U_C)	34.8 V
Max. continuous operating voltage (a.c.) (U_C)	24.5 V
Max. input voltage acc. to EN 60079-11 (U_i)	30 V
Max. input current acc. to EN 60079-11 (I_i)	0.5 A
Nominal current (I_N)	0.5 A
D1 Lightning impulse current (10/350 μ s) per line (I_{imp})	1 kA
C2 Total nominal discharge current (8/20 μ s) (I_n)	10 kA
C2 Nominal discharge current (8/20 μ s) per line (I_n)	5 kA
Voltage protection level line-line for I_n C2 (U_p)	≤ 55 V
Voltage protection level line-PG for I_n C2 (U_p)	≤ 1100 V
Voltage protection level line-line at 1 kV/ μ s C3 (U_p)	≤ 49 V
Voltage protection level line-PG at 1 kV/ μ s C3 (U_p)	≤ 1000 V
Cut-off frequency line-line (f_c)	7 MHz
Capacitance line-line (C)	≤ 850 pF
Capacitance line-PG (C)	≤ 15 pF
Series resistance per line	1.8 ohms
Operating temperature range (T_U)	-40 °C ... +80 °C
Degree of protection	IP 67
For mounting on (field / device side)	M20 x 1.5 female thread / M20 x 1.5 male thread
Connection (input / output)	screw / connecting lines (1.5 mm ²)
Length of the connecting lead	200 mm
Cross-sectional area, solid	0.08-2.5 mm ²
Cross-sectional area, flexible	0.08-1.5 mm ²
Earthing via	enclosure
Enclosure material	StSt (V2A)
Colour	bare surface
Test standards	IEC 61643-21 / EN 61643-21
Approvals	EACEx, ATEX, IECEx, SIL
ATEX approvals	DEKRA 11ATEX0076 X: II 2 (1) G Ex ia [ia Ga] IIC T4 ... T6 Gb
IECEx approvals	DEK 11.0025X: Ex ia [ia Ga] IIC T4 ... T6 Gb
CSA & USA Hazloc approvals (1)	CSA17CA.70144338: Ex ia [ia Ga] IIC T4 ... T6 Gb
CSA & USA Hazloc approvals (2)	CSA17CA.70144338: Class I Div 1; Class I Zone 1
SIL classification	up to SIL3 ^{*)}
Weight	172 g
Customs tariff number (Comb. Nomenclature EU)	85363010
GTIN	4013364098145
PU	1 pc(s)

^{*)} For details see: www.dehn-international.com

DEHNprotector

DPRO 230 ISDN (909 320)

- Surge protective device for ISDN or Ethernet components (10 BASE-T) with a modern design
- For installation in conformity with the lightning protection zone concept at the boundaries from 2 – 3 and higher

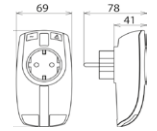
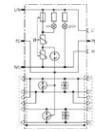

Combined surge protection for the power and ISDN S₀ side of ISDN systems and devices. Shielded port allows to protect Ethernet 10 BT. With visual operating state and fault indication and integrated child lock.

Protection of the data side

Type Part No.	DPRO 230 ISDN 909 320
SPD class	TYPE 2/P1
Max. continuous operating voltage (d.c.) (U _c)	48 V
Lightning impulse current (10/350 μs) per line D1 (I _{imp})	1 kA
C2 Nominal discharge current (8/20 μs) line-line (I _n)	120 A
C2 Nominal discharge current (8/20 μs) line-PE (I _n)	2.5 kA
C2 Total nominal discharge current (8/20 μs) (I _n)	10 kA
Voltage protection level line-line for I _n C2 (U _p)	≤ 100 V
Voltage protection level line-PE for I _n C2 (U _p)	≤ 500 V
Voltage protection level line-line at 1 kV/μs C3 (U _p)	≤ 80 V
Voltage protection level line-PE at 1 kV/μs C3 (U _p)	≤ 500 V
Cut-off frequency (f _c)	50 MHz
Operating temperature range (T _U)	-25 °C ... +40 °C
Degree of protection	IP 20
Connection (input / output)	shielded RJ45 socket / shielded RJ45 socket
Pinning	1(5)/2(4), 3/6
Earthing via	protective conductor connection
Enclosure material	thermoplastic, UL 94 V-2
Colour	pure white
Test standards	IEC 61643-21 / EN 61643-21

Protection of the power side

Type Part No.	DPRO 230 ISDN 909 320
SPD according to EN 61643-11 / IEC 61643-11	type 3 / class III
Nominal voltage (a.c.) (U _N)	230 V (50 / 60 Hz)
Max. continuous operating voltage (a.c.) (U _c)	255 V (50 / 60 Hz)
Nominal load current (a.c.) (I _L)	16 A
Nominal discharge current (8/20 μs) (I _n)	3 kA
Total discharge current (8/20 μs) [L+N-PE] (I _{total})	5 kA
Combination wave (U _{oc})	6 kV
Combination wave [L+N-PE] (U _{oc total})	10 kV
Voltage protection level [L-N] (U _p)	≤ 1.25 kV
Voltage protection level [L/N-PE] (U _p)	≤ 1.5 kV
Response time [L-N] (t _A)	≤ 25 ns
Response time [L/N-PE] (t _A)	≤ 100 ns
Max. mains-side overcurrent protection	B 16 A
Short-circuit withstand capability for mains-side overcurrent protection (I _{SCCR})	1 kA _{rms}
Temporary overvoltage (TOV) [L-N] (U _T) – Characteristic	335 V / 5 sec. – withstand
Temporary overvoltage (TOV) [L-N] (U _T) – Characteristic	440 V / 120 min. – safe failure
Temporary overvoltage (TOV) [L/N-PE] (U _T) – Characteristic	335 V / 120 min. – withstand
Temporary overvoltage (TOV) [L/N-PE] (U _T) – Characteristic	440 V / 5 sec. – withstand
Temporary overvoltage (TOV) [L+N-PE] (U _T) – Characteristic	1200 V + U _{REF} / 200 ms – safe failure
Fault indication	red indicator light
Operating state indication	green indicator light
Number of ports	1
For mounting on	earthed socket outlets DIN 49440 / DIN 49441
Test standards	EN 61643-11
Weight	215 g
Customs tariff number (Comb. Nomenclature EU)	85363010
GTIN	4013364136885
PU	1 pc(s)

HVI

FM 60 L11M IP HVI M L10M GFK AL STTZN (819 730)



Figure without obligation

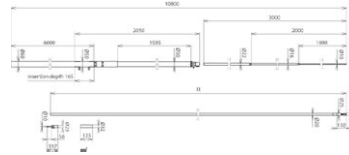

Type	FM 60 L11M IP HVI M L10M GFK AL STTZN
Part No.	819 730
Total length of air-termination mast	10800 mm
Length of air-termination rod	3000 mm
Material of air-termination rod	Al
Length of supporting tube	2100 mm
Material of supporting tube	GRP / Al
Length of mast pipe	6000 mm
Material of mast pipe	St/tZn
Diameter Ø conductor	20 mm
Lightning current carrying capability (class / I _{imp})	H1 / 150 kA
Colour of conductor	black ●
Material of conductor	Cu
Minimum order length	10.0 m
Max. gust wind speed	166 km/h
Weight	53 kg
Customs tariff number (Comb. Nomenclature EU)	85389099
GTIN	4013364243477
PU	1 pc(s)

FM 60 L11M IP HVIP L10M GFK AL STTZN (819 760)



Figure without obligation

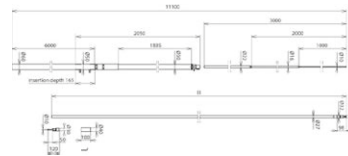

Type	FM 60 L11M IP HVIP L10M GFK AL STTZN
Part No.	819 760
Total length of air-termination mast	11000 mm
Length of air-termination rod	3000 mm
Material of air-termination rod	Al
Length of supporting tube	2300 mm
Material of supporting tube	GRP / Al
Length of mast pipe	6000 mm
Material of mast pipe	St/tZn
Diameter Ø conductor	27 mm
Lightning current carrying capability (class / I _{imp})	H2 / 200 kA
Colour of conductor	black ●
Material of conductor	Cu
Minimum order length	10 m
Maximum order length	35 m
Suitable for installation outside of tube	no
Max. gust wind speed	147 km/h
Weight	56,64 kg
Customs tariff number (Comb. Nomenclature EU)	85389099
GTIN	4013364240391
PU	1 pc(s)

DEHNiso-Combi

DICS WB D50 10 5700 GFK AL V2A (105 455)



Figure without obligation

Type Part No.	DICS WB D50 10 5700 GFK AL V2A 105 455
Total length	5700 mm
Quantity of spacers	2
Quantity of fixing brackets	3
Length of supporting tube	4700 mm
Max. gust wind speed	130 km/h
Material of supporting tube	GRP / Al
Type	one-piece
Length of air-termination rod	1000 mm
Material of air-termination rod	Al
Length of spacer	1030 mm
Material of spacer	GRP-Al-St/tZn
Material factor km	0.7
Material of fixing bracket	StSt
Permanent temperature range	-50 °C ... +100 °C
Weight	11,45 kg
Customs tariff number (Comb. Nomenclature EU)	85389099
GTIN	4013364099715
PU	1 pc(s)

FSP 10 1000 MVK 8.10 V2A (105 071)

For screwing in.



Type Part No.	FSP 10 1000 MVK 8.10 V2A 105 071
Material of air-termination rod	StSt
Material of MV clamp	StSt
Air-termination rod (l x Ø)	1000 x 10 mm
Clamping range Rd	8-10 mm
Thread	M10
Standard	EN 62561-(1+2)
Weight	694 g
Customs tariff number (Comb. Nomenclature EU)	85389099
GTIN	4013364101456
PU	1 pc(s)



DEHNiso-Combi

SR D50 M10 4700 GFK AL (105 301)

For isolated installation of air-termination systems with female thread for air-termination rod or MV clamp for spanning cables.
One-piece.



Type	SR D50 M10 4700 GFK AL
Part No.	105 301
Material of supporting tube	GRP / Al
Length of supporting tube (l1)	4700 mm
Diameter Ø outside	50 mm
Transport length	4700 mm
Length of insulating clearance	1535 mm
Permanent temperature range	-50 °C ... +100 °C
Weight	7,2 kg
Customs tariff number (Comb. Nomenclature EU)	85389099
GTIN	4013364098541
PU	1 pc(s)



WB D50 WA V2A (105 340)

For fastening of supporting tubes on a structure or wall.



Type	WB D50 WA V2A
Part No.	105 340
Material	StSt
Clamping range of supporting tube	50 mm
Wall / corner distance	80 mm
Dimension of fixing	320 mm
Fixing	[8x] Ø5.1 / [4x] 11 x 20 mm
Material of screw	StSt
Weight	618 g
Customs tariff number (Comb. Nomenclature EU)	85389099
GTIN	4013364098794
PU	1 pc(s)

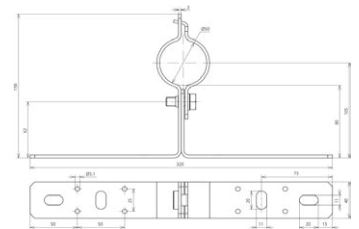

DIDH 7.10 1030 D50 V2A (106 331)

For fixing of conductors on the supporting tube and for keeping the separation distance according to IEC/EN 62305.



Type	DIDH 7.10 1030 D50 V2A
Part No.	106 331
Material of spacer	GRP
Material of fixing element	StSt
Material of conductor holder	StSt
Conductor holder support Rd	7-10 mm
Height of conductor holder	20 mm
Total length (l1)	1030 mm
Insulating clearance (l2)	945 mm
Clamping range of supporting tube	50 mm
Permanent temperature range	-50 °C ... +100 °C
Weight	715 g
Customs tariff number (Comb. Nomenclature EU)	85389099
GTIN	4013364100367
PU	1 pc(s)

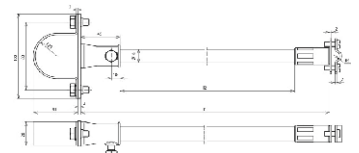

Round wire



RD 10 V4A R80M (860 010)

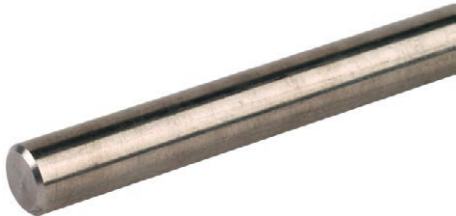

Figure without obligation

Stainless steel wire according to EN 62561-2, for use in lightning protection and earth-termination systems or equipotential bonding.

Stainless steel wire for use in soil has to be made of StSt (V4A) with a molybdenum proportion > 2 % e.g. 1.4571, 1.4404, in accordance with EN 62561-2 and IEC/EN 62305-3.

Type Part No.	RD 10 V4A R80M 860 010
Diameter Ø conductor	10 mm
Cross-section	78 mm ²
Material	StSt (V4A)
Material No.	1.4571 / 1.4404
ASTM / AISI:	316Ti / 316L
Standard	based on EN 62561-2
Conductivity	≥ 1.25 m / Ohm mm ²
Resistivity	≤ 0.8 Ohm mm ² / m
Short-circuit current (50 Hz) (1 s; ≤ 300 °C)	2.9 kA
Weight	617 g/m
Customs tariff number (Comb. Nomenclature EU)	72210010
GTIN	4013364019997
PU	80 m

AF 10 V4A 1500 (860 115)

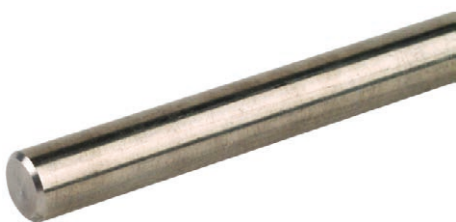

Figure without obligation



Made of corrosion resistant stainless steel StSt (V4A), for the connection of down conductors with the earth-termination system.

Type Part No.	AF 10 V4A 1500 860 115
Material	StSt (V4A)
Material No.	1.4571 / 1.4404
ASTM / AISI:	316Ti / 316L
Length (l1)	1500 mm
Dimension	Ø10 mm
Cross-section	78 mm ²
Standard	EN 62561-2
Weight	930 g
Customs tariff number (Comb. Nomenclature EU)	85389099
GTIN	4013364101104
PU	5 pc(s)

Flat strip

AF 30X3.5 V4A 1500 (860 215)

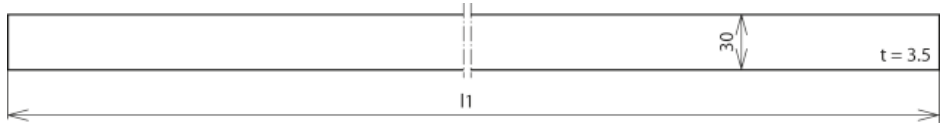

Figure without obligation

Made of corrosion resistant stainless steel StSt (V4A), for connecting down conductors to the earth-termination system.

Type	AF 30X3.5 V4A 1500
Part No.	860 215
Material	StSt (V4A)
Material No.	1.4571 / 1.4404
ASTM / AISI:	316Ti / 316L
Length (l1)	1500 mm
Dimension	30 x 3.5 mm
Cross-section	105 mm ²
Standard	EN 62561-2
Weight	1,25 kg
Customs tariff number (Comb. Nomenclature EU)	85389099
GTIN	4013364101081
PU	5 pc(s)



BA 30X3.5 V4A R60M (860 335)



Figure without obligation

Stainless steel strip according to EN 62561-2, for use in lightning protection systems and ring equipotential bonding.

Stainless steel strip for use in soil has to be made of StSt (V4A) with a molybdenum content of > 2 % e.g. 1.4571, 1.4404 in accordance with EN 62561-2 and IEC/EN 62305-3 and DIN VDE 0151.

Type	BA 30X3.5 V4A R60M
Part No.	860 335
Width	30 mm
Thickness	3.5 mm
Cross-section	105 mm ²
Material	StSt (V4A)
Material No.	1.4571 / 1.4404
ASTM / AISI:	316Ti / 316L
Standard	EN 62561-2
Conductivity	≥ 1.25 m / Ohm mm ²
Resistivity	≤ 0.8 Ohm mm ² / m
Short-circuit current (50 Hz) (1 s; ≤ 300 °C)	3.9 kA
Weight	827 g/m
Customs tariff number (Comb. Nomenclature EU)	72202021
GTIN	4013364143388
PU	60 m

SV clamp

 **SVK 7.10 7.10 FL30 V4A (308 229)**

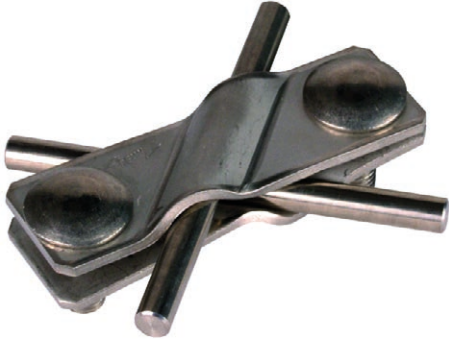
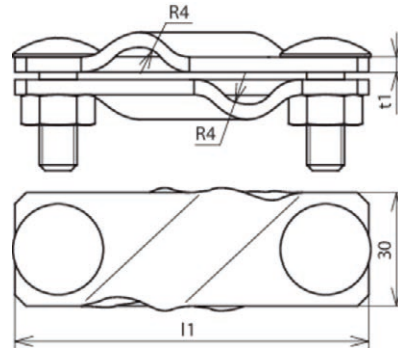

Figure without obligation



Type	SVK 7.10 7.10 FL30 V4A
Part No.	308 229
Material of clamp	StSt (V4A)
Clamping range Rd / Rd	7-10 / 7-10 mm
Clamping range Rd / FI	7-10 / 30 mm
Clamping range FI / FI	30 / 30 mm
Clamping range (stranded / cable)	50-70 mm ²
Screw	⬆ M10 x 30 mm
Material of screw / nut	StSt (V4A)
Material No.	1.4571 / 1.4404 / 1.4401
ASTM / AISI:	316Ti / 316L / 316
Dimension (l1 x t1)	94 x 3 mm
Standard	EN 62561-1
Short-circuit current (50 Hz) (1 s; ≤ 300 °C)	3.2 kA
Weight	190 g
Customs tariff number (Comb. Nomenclature EU)	85389099
GTIN	4013364083745
PU	25 pc(s)

Cross section

 **KS 8.10 8.10 FL30 ZP V4A (319 209)**

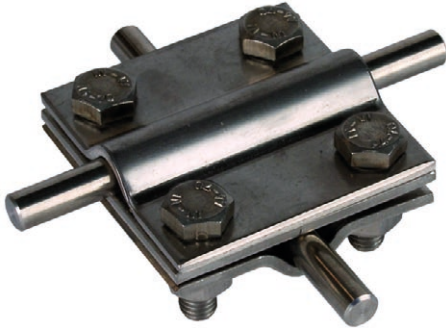
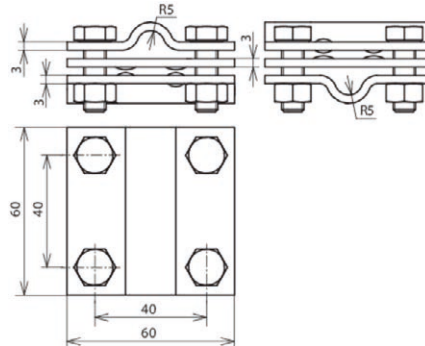

Figure without obligation



Type Part No.	KS 8.10 8.10 FL30 ZP V4A 319 209
Material of clamp	StSt (V4A)
Clamping range Rd / Rd	8-10 / 8-10 mm
Clamping range Rd / FI	8-10 / 30 mm
Clamping range FI / FI	30 / 30 mm
Clamping range (stranded / cable)	50-70 mm ²
Screw	☒ M8 x 25 mm
Material of screw / nut	StSt (V4A)
Material No.	1.4571 / 1.4404 / 1.4401
ASTM / AISI:	316Ti / 316L / 316
Dimension	60 x 60 x 3 mm
Intermediate plate	yes
Standard	EN 62561-1
Short-circuit current (50 Hz) (1 s; ≤ 300 °C)	7 kA
Weight	313 g
Customs tariff number (Comb. Nomenclature EU)	85389099
GTIN	4013364035980
PU	25 pc(s)

Earthing busbar

ES 2X6 ASB11 V2A (472 139)



Figure without obligation

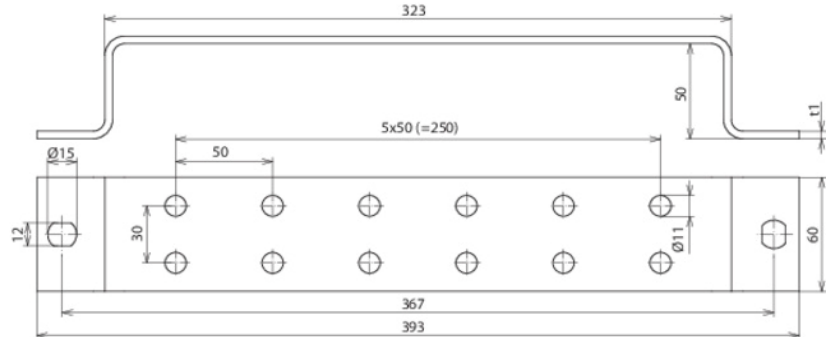

Type	ES 2X6 ASB11 V2A
Part No.	472 139
Material	StSt
Cross-section	300 mm ²
Connection bores Ø	11 mm
Dimension (l x w x d1)	393 x 60 x 5 mm
Fixing	[2x] 12 x 15 mm
Standard	EN 62561-1
Weight	1,1 kg
Customs tariff number (Comb. Nomenclature EU)	85389099
GTIN	4013364074507
PU	1 pc(s)

Anti-corrosion tape

KSB 50 L10M (556 125)



Figure without obligation

Anti-corrosion tape for coating of aboveground and underground connections
For use in the soil according to DIN 30672. In reels, length 10 m, UV stabilised.

Type	KSB 50 L10M
Part No.	556 125
Material	petrolatum
Length	10 m
Width	50 mm
Strenght	approx. 1 mm
Standard	DIN 30672
Type	UV stabilised
Weight	560 g
Customs tariff number (Comb. Nomenclature EU)	68071000
GTIN	4013364028517
PU	24 pc(s)

Equipotential busbar

 **PAS I 6AP M10 V2A (472 209)**



Figure without obligation

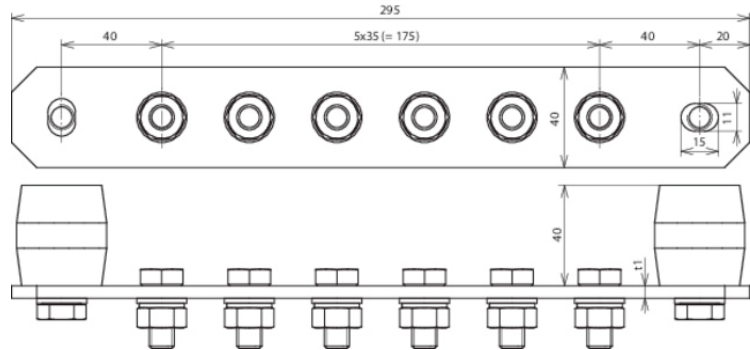

Type	PAS I 6AP M10 V2A
Part No.	472 209
Quantity of terminals	6
Material	StSt
Material No.	1.4301 / 1.4303
Dimension (l x w x d1)	295 x 40 x 6 mm
Cross-section	240 mm ²
Short-circuit current (50 Hz) (1 s; ≤ 300 °C)	8.9 kA
Screw	 M10 x 25 mm
Material of screw / nut	StSt
Design	with spring washer
Material of insulator	UP
Colour of insulator	red •
Standard	EN 62561-1
Weight	1,01 kg
Customs tariff number (Comb. Nomenclature EU)	85389099
GTIN	4013364090934
PU	1 pc(s)

Surge Protection
Lightning Protection
Safety Equipment
DEHN protects.

DEHN SE
Hans-Dehn-Str. 1
Postfach 1640
92306 Neumarkt, Germany

Tel. +49 9181 906-0
Fax +49 9181 906-1100
info@dehn.de
www.dehn-international.com



www.dehn-international.com/partners

Type designations of products mentioned in this white paper which are at the same time registered trademarks are not especially marked. Hence the absence of TM or [®] markings does not indicate that the type designation is a free trade name. Nor can it be seen whether patents or utility models and other intellectual and industrial property rights exist. We reserve the right to introduce changes in performance, configuration and technology, dimensions, weights and materials in the course of technical progress. The figures are shown without obligation. Misprints, errors and modifications excepted. Reproduction in any form whatsoever is forbidden without our authorisation.