



Surge protection for agricultural buildings

White Paper



Contents

Surge protective devices
for an agricultural building

Surge protective devices for bus
systems and the telephones

Example of surge protective
devices for an agricultural
building with robotic milking
system

Surge protection for agricultural buildings

White Paper

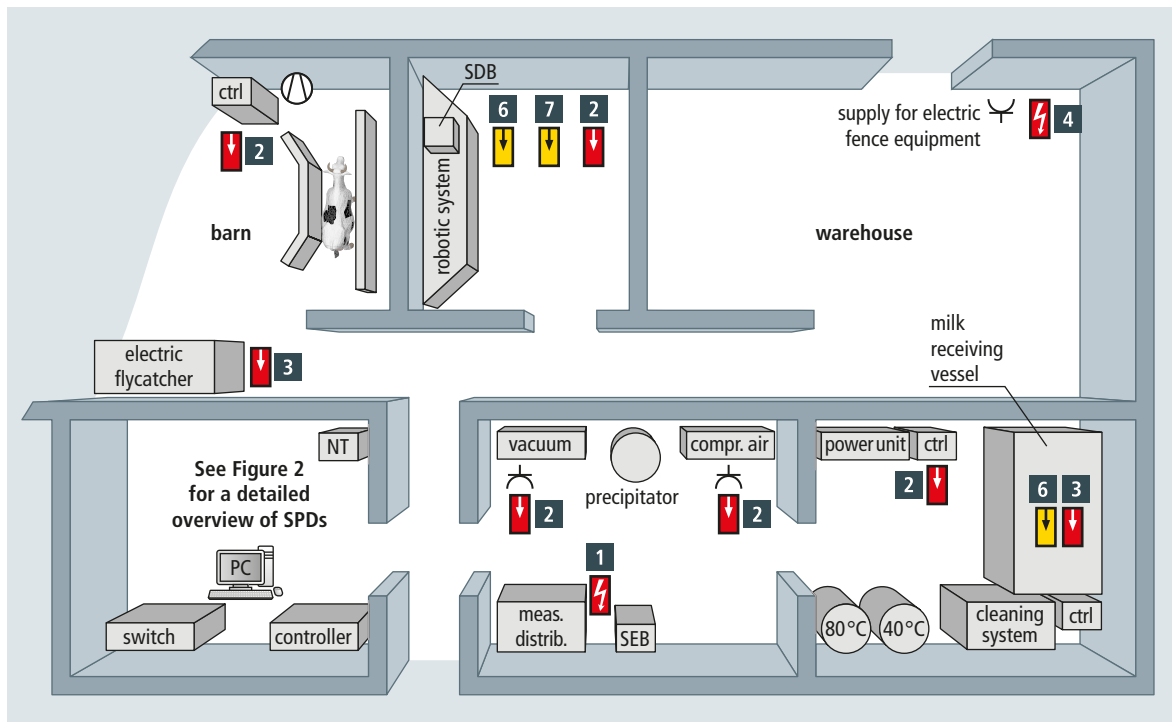

Figure 1 Surge protective devices for an agricultural building

No. in Figure 1 and 2	Surge protective device		Part No.
1	DEHNventil	DV M TNC 255	951 300
	DEHNventil	DV M TT 255	951 310
	<i>alternative:</i>		
	DEHNshield	DSH TNC 255	941 300
2	DEHNshield	DSH TT 255	941 310
3	DEHnrail	DR M 4P 255	3/N/PE ≤ 25 A
3	DEHnrail	DR M 2P 255	1/N/PE ≤ 25 A
	DEHNflex	DFL A 255	1/N/PE ≤ 16 A
4	DEHNshield	DSH TT 2P 255	
5	SFL Protector	SFL PRO 6X	Multiple socket outlet
6	BLITZDUCTOR	BSP M2 BE HF 5	CAN bus or ALCOM bus
	+ base part	BXT BAS	
7	DEHNpatch	DPA M CLE RJ45B 48	LAN
8	BLITZDUCTOR	BXT ML2 BD 180	Telephone U _{K0}
	+ base part	BXT BAS	
	<i>alternative:</i>		
	DEHNbox	DBX TC 180	922 210

Table 1 Example of surge protective devices for an agricultural building with robotic milking system (technical data of the manufacturer must be observed)

Surge protection for agricultural buildings

White Paper



Complex electrical and information technology systems shape the image of modern agriculture. These systems are used to optimise and, if possible, automate time-consuming processes to increase the revenue.

For dairy animal breeding, this means

- ➔ That the fully automated milking system/feeding station identifies the transponder of the cow and controls the milking process or the food volume;
- ➔ That fresh milk is analysed for the presence of blood/infections and is discarded or transferred to the milk receiving vessel;
- ➔ That the milk from the milking system is cooled in the milk receiving vessel and the waste heat of the compressor is passed through a heat exchanger to heat the water in an industrial water boiler (reduced costs by heating industrial water);
- ➔ That the cleaning system rinses the milk hoses;
- ➔ That the vacuum system provides a vacuum to extract milk from the cow;
- ➔ That compressed air is produced to actuate the entrance gates of the robotic milking system, position the feeding trough/droppings box and supply the forced cow traffic system;
- ➔ That electric flycatchers minimise fly populations and thus disease transmission;
- ➔ That ventilators improve the climate in the barn and thus animal health/milk quality.

Figure 1 shows an example of an agricultural building with robotic milking system. The individual systems are controlled via several data lines (**Figure 2**). The operator can access the entire building via modem.

In subsection 705.443 of the IEC 60364-7-705 (HD 60364-7-705) standard it is recommended that lightning and surge protec-

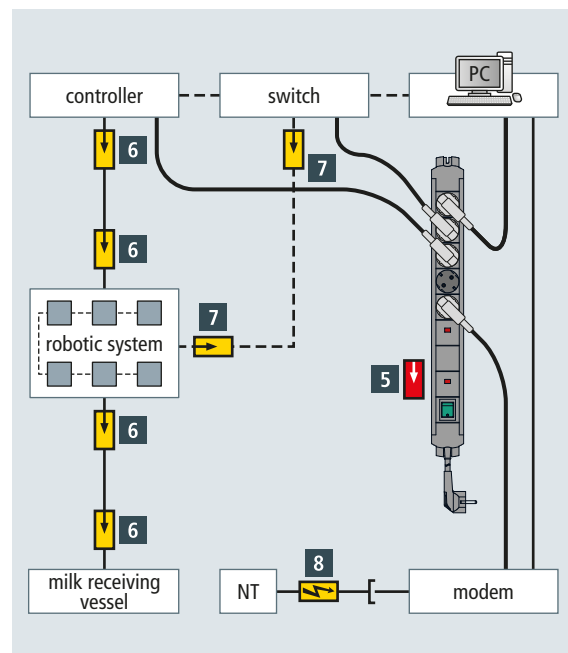

Figure 2 Surge protective devices for bus systems and the telephone

tion measures be taken if electronic equipment is installed. **Table 1** shows suitable surge protective devices for the sample building (**Figures 1 and 2**).

Protective equipotential bonding according to IEC 60364-5-54 (HD 60364-5-54) as well as supplementary protective equipotential bonding for agricultural and horticultural premises according to IEC 60364-7-705 (HD 60364-7-705) is important to protect agricultural buildings against surges. These standards describe how to integrate extraneous conductive parts in the floor of the standing, lying and milking area (also recommended for slatted floors made of concrete).

DEHNventil

DV M TNC 255 (951 300)

- Prewired combined type 1 and type 2 spark-gap-based lightning current and surge arrester consisting of a base part and plug-in protection modules
- Maximum system availability due to RADAX Flow follow current limitation
- Capable of protecting terminal equipment



Figure without obligation

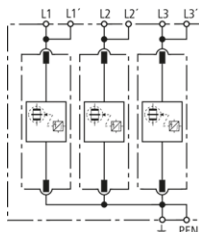

Basic circuit diagram DV M TNC 255

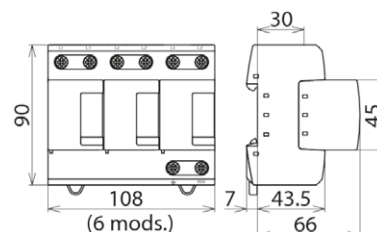

Dimension drawing DV M TNC 255

Modular combined lightning current and surge arrester for protecting TN-C systems against surges.

Type Part No.	DV M TNC 255 951 300
SPD according to EN 61643-11 / IEC 61643-11	type 1 + type 2 / class I + class II
Energy coordination with terminal equipment (≤ 5 m)	type 1 + type 2 + type 3
Nominal a.c. voltage (U_N)	230 / 400 V (50 / 60 Hz)
Max. continuous operating a.c. voltage (U_c)	264 V (50 / 60 Hz)
Lightning impulse current (10/350 μ s) [L1+L2+L3-PEN] (I_{total})	75 kA
Specific energy [L1+L2+L3-PEN] (W/R)	1.40 MJ/ohms
Lightning impulse current (10/350 μ s) [L-PEN] (I_{imp})	25 kA
Specific energy [L-PEN] (W/R)	156.25 kJ/ohms
Nominal discharge current (8/20 μ s) [L-PEN]/[L1+L2+L3-PEN] (I_n)	25 / 75 kA
Voltage protection level (U_p)	≤ 1.5 kV
Follow current extinguishing capability a.c. (I_n)	50 kA _{rms}
Follow current limitation / Selectivity	no tripping of a 20 A gL/gG fuse up to 50 kA _{rms} (prosp.)
Response time (t_A)	≤ 100 ns
Max. backup fuse (L) up to $I_K = 50$ kA _{rms}	315 A gG
Max. backup fuse (L-L')	125 A gG
Temporary overvoltage (TOV) (U_T) – Characteristic	440 V / 120 min. – withstand
Operating temperature range [parallel] / [series] (T_U)	-40 °C ... +80 °C / -40 °C ... +60 °C
Operating state / fault indication	green / red
Number of ports	1
Cross-sectional area (L1, L1', L2, L2', L3, L3', PEN, \pm) (min.)	10 mm ² solid / flexible
Cross-sectional area (L1, L2, L3, PEN) (max.)	50 mm ² stranded / 35 mm ² flexible
Cross-sectional area (L1', L2', L3', \pm) (max.)	35 mm ² stranded / 25 mm ² flexible
For mounting on	35 mm DIN rails acc. to EN 60715
Enclosure material	thermoplastic, red, UL 94 V-0
Place of installation	indoor installation
Degree of protection	IP 20
Capacity	6 module(s), DIN 43880
Approvals	KEMA, VDE, UL, VdS
Extended technical data:	Use in switchgear installations with prospective short-circuit currents of more than 50 kA _{rms} (tested by the German VDE)
– Max. prospective short-circuit current	100 kA _{rms} (220 kA _{peak})
– Limitation / Extinction of mains follow currents	up to 100 kA _{rms} (220 kA _{peak})
– Max. backup fuse (L) up to $I_K = 100$ kA _{rms}	315 A gL/gG
Weight	970 g
Customs tariff number	85363030
GTIN	4013364108134
PU	1 pc(s)

DEHNventil

DV M TT 255 (951 310)

- Prewired spark-gap-based type 1 and type 2 combined lightning current and surge arrester consisting of a base part and plug-in protection modules
- Maximum system availability due to RADAX Flow follow current limitation
- Capable of protecting terminal equipment



Figure without obligation

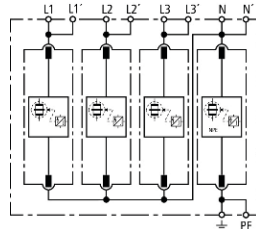

Basic circuit diagram DV M TT 255

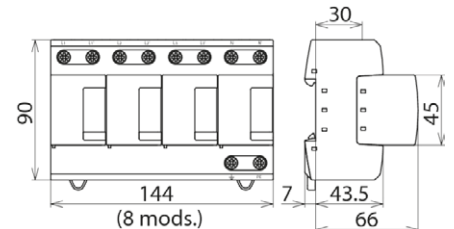

Dimension drawing DV M TT 255

Modular combined lightning current and surge arrester for TT and TN-S systems ("3+1" circuit).

Type Part No.	DV M TT 255 951 310
SPD according to EN 61643-11 / IEC 61643-11	type 1 + type 2 / class I + class II
Energy coordination with terminal equipment (≤ 5 m)	type 1 + type 2 + type 3
Nominal a.c. voltage (U_N)	230 / 400 V (50 / 60 Hz)
Max. continuous operating a.c. voltage [L-N] (U_C)	264 V (50 / 60 Hz)
Max. continuous operating a.c. voltage [N-PE] ($U_{C(N-PE)}$)	255 V (50 / 60 Hz)
Lightning impulse current (10/350 μ s) [L1+L2+L3+N-PE] (I_{total})	100 kA
Specific energy [L1+L2+L3+N-PE] (W/R)	2.50 MJ/ohms
Lightning impulse current (10/350 μ s) [L-N]/[N-PE] (I_{imp})	25 / 100 kA
Specific energy [L-N]/[N-PE] (W/R)	156.25 kJ/ohms / 2.50 MJ/ohms
Nominal discharge current (8/20 μ s) [L-N]/[N-PE] (I_n)	25 / 100 kA
Voltage protection level [L-N]/[N-PE] (U_p)	≤ 1.5 / ≤ 1.5 kV
Follow current extinguishing capability [L-N]/[N-PE] (I_n)	50 kA _{rms} / 100 A _{rms}
Follow current limitation / Selectivity	no tripping of a 20 A gL/gG fuse up to 50 kA _{rms} (prosp.)
Response time (t_A)	≤ 100 ns
Max. backup fuse (L) up to $I_K = 50$ kA _{rms}	315 A gG
Max. backup fuse (L-L')	125 A gG
Temporary overvoltage (TOV) [L-N] (U_T) – Characteristic	440 V / 120 min. – withstand
Temporary overvoltage (TOV) [N-PE] (U_T) – Characteristic	1200 V / 200 ms – withstand
Operating temperature range [parallel] / [series] (T_U)	-40 °C ... +80 °C / -40 °C ... +60 °C
Operating state / fault indication	green / red
Number of ports	1
Cross-sectional area (L1, L1', L2, L2', L3, L3', N, N', PE, \pm) (min.)	10 mm ² solid / flexible
Cross-sectional area (L1, L2, L3, N, PE) (max.)	50 mm ² stranded / 35 mm ² flexible
Cross-sectional area (L1', L2', L3', N', \pm) (max.)	35 mm ² stranded / 25 mm ² flexible
For mounting on	35 mm DIN rails acc. to EN 60715
Enclosure material	thermoplastic, red, UL 94 V-0
Place of installation	indoor installation
Degree of protection	IP 20
Capacity	8 module(s), DIN 43880
Approvals	KEMA, VDE, UL, VdS
Extended technical data:	Use in switchgear installations with prospective short-circuit currents of more than 50 kA _{rms} (tested by the German VDE)
– Max. prospective short-circuit current	100 kA _{rms} (220 kA _{peak})
– Limitation / Extinction of mains follow currents	up to 100 kA _{rms} (220 kA _{peak})
– Max. backup fuse (L) up to $I_K = 100$ kA _{rms}	315 A gL/gG
Weight	1,27 kg
Customs tariff number	85363030
GTIN	4013364108172
PU	1 pc(s)

DEHNshield

DSH TT 2P 255 (941 110)

- Application-optimised and prewired spark-gap-based type 1 and type 2 combined lightning current and surge arrester
- Space-saving arrester for compact and simply equipped electrical installations with reduced technical requirements
- Capable of protecting terminal equipment



Figure without obligation

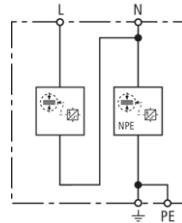

Basic circuit diagram DSH TT 2P 255

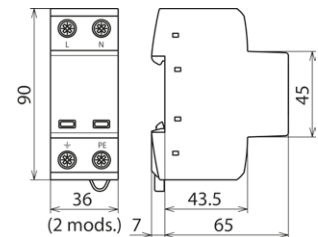

Dimension drawing DSH TT 2P 255

Application-optimised and prewired combined lightning current and surge arrester for single-phase TT and TN-S systems ("1+1" circuit).

Type	DSH TT 2P 255
Part No.	941 110
SPD according to EN 61643-11 / IEC 61643-11	type 1 + type 2 / class I + class II
Energy coordination with terminal equipment (≤ 5 m)	type 1 + type 2 + type 3
Nominal a.c. voltage (U_N)	230 V (50 / 60 Hz)
Max. continuous operating a.c. voltage (U_C)	255 V (50 / 60 Hz)
Lightning impulse current (10/350 μ s) [L+N-PE] (I_{total})	25 kA
Specific energy [L+N-PE] (W/R)	156.25 kJ/ohms
Lightning impulse current (10/350 μ s) [L-N]/[N-PE] (I_{imp})	12.5 / 25 kA
Specific energy [L-N]/[N-PE] (W/R)	39.06 / 156.25 kJ/ohms
Nominal discharge current (8/20 μ s) [L-N]/[N-PE] (I_n)	12.5 / 25 kA
Voltage protection level [L-N]/[N-PE] (U_p)	≤ 1.5 / ≤ 1.5 kV
Follow current extinguishing capability [L-N]/[N-PE] (I_{fl})	25 kA _{rms} / 100 A _{rms}
Follow current limitation / Selectivity	no tripping of a 32 A gL/gG fuse up to 25 kA _{rms} (prosp.)
Response time (t_A)	≤ 100 ns
Max. mains-side overcurrent protection	160 A gL/gG
Temporary overvoltage (TOV) [L-N] (U_T) – Characteristic	440 V / 120 min. – withstand
Temporary overvoltage (TOV) [N-PE] (U_T) – Characteristic	1200 V / 200 ms – withstand
Operating temperature range (T_U)	-40 °C ... +80 °C
Operating state / fault indication	green / red
Number of ports	1
Cross-sectional area (L, N, PE, \pm) (min.)	1.5 mm ² solid / flexible
Cross-sectional area (L, N, PE, \pm) (max.)	35 mm ² stranded / 25 mm ² flexible
For mounting on	35 mm DIN rails acc. to EN 60715
Enclosure material	thermoplastic, red, UL 94 V-0
Place of installation	indoor installation
Degree of protection	IP 20
Capacity	2 module(s), DIN 43880
Approvals	KEMA, VDE, UL
Weight	275 g
Customs tariff number	85363030
GTIN	4013364137899
PU	1 pc(s)

DEHNshield

DSH TNC 255 (941 300)

- Application-optimised and prewired type 1 and type 2 spark-gap-based combined lightning current and surge arrester
- Space-saving arrester for compact and simply equipped electrical installations with reduced technical requirements
- Capable of protecting terminal equipment



Figure without obligation

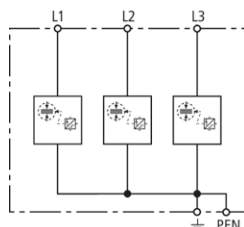

Basic circuit diagram DSH TNC 255

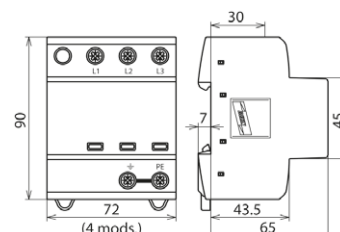

Dimension drawing DSH TNC 255

Application-optimised and prewired combined lightning current and surge arrester for TN-C systems.

Type	DSH TNC 255
Part No.	941 300
SPD according to EN 61643-11 / IEC 61643-11	type 1 + type 2 / class I + class II
Energy coordination with terminal equipment (≤ 5 m)	type 1 + type 2 + type 3
Nominal a.c. voltage (U_N)	230 / 400 V (50 / 60 Hz)
Max. continuous operating a.c. voltage (U_C)	255 V (50 / 60 Hz)
Lightning impulse current (10/350 μ s) [L1+L2+L3-PEN] (I_{total})	37.5 kA
Specific energy [L1+L2+L3-PEN] (W/R)	352.00 kJ/ohms
Lightning impulse current (10/350 μ s) [L-PEN] (I_{imp})	12.5 kA
Specific energy [L-PEN] (W/R)	39.06 kJ/ohms
Nominal discharge current (8/20 μ s) [L-PEN]/[L1+L2+L3-PEN] (I_n)	12.5 / 37.5 kA
Nominal discharge current (8/20 μ s) [L/N-PE]/[L1+L2+L3+N-PE] (I_n)	1 kA
Voltage protection level (U_p)	≤ 1.5 kV
Follow current extinguishing capability a.c. (I_{fi})	25 kA _{rms}
Follow current limitation / Selectivity	no tripping of a 32 A gL/gG fuse up to 25 kA _{rms} (prosp.)
Response time (t_A)	≤ 100 ns
Max. mains-side overcurrent protection	160 A gL/gG
Temporary overvoltage (TOV) [L-N] (U_T) – Characteristic	440 V / 120 min. – withstand
Operating temperature range (T_U)	-40 °C ... +80 °C
Operating state / fault indication	green / red
Number of ports	1
Cross-sectional area (L1, L2, L3, PEN) (min.)	1.5 mm ² solid / flexible
Cross-sectional area (L1, L2, L3, PEN) (max.)	35 mm ² stranded / 25 mm ² flexible
For mounting on	35 mm DIN rails acc. to EN 60715
Enclosure material	thermoplastic, red, UL 94 V-0
Place of installation	indoor installation
Degree of protection	IP 20
Capacity	4 module(s), DIN 43880
Approvals	KEMA, VDE, UL
Weight	386 g
Customs tariff number	85363030
GTIN	4013364133556
PU	1 pc(s)

DEHNshield

DSH TT 255 (941 310)

- Application-optimised and prewired spark-gap-based type 1 and type 2 combined lightning current and surge arrester
- Space-saving arrester for compact and simply equipped electrical installations with reduced technical requirements
- Capable of protecting terminal equipment



Figure without obligation

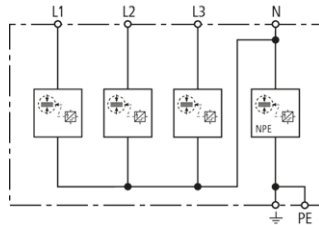

Basic circuit diagram DSH TT 255

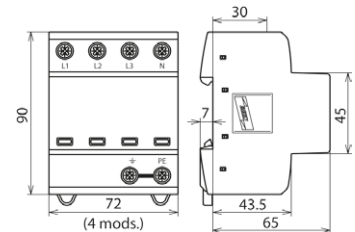

Dimension drawing DSH TT 255

Application-optimised and prewired combined lightning current and surge arrester for TT and TN-S systems ("3+1" circuit).

Type Part No.	DSH TT 255 941 310
SPD according to EN 61643-11 / IEC 61643-11	type 1 + type 2 / class I + class II
Energy coordination with terminal equipment (≤ 5 m)	type 1 + type 2 + type 3
Nominal a.c. voltage (U_N)	230 / 400 V (50 / 60 Hz)
Max. continuous operating a.c. voltage (U_C)	255 V (50 / 60 Hz)
Lightning impulse current (10/350 μ s) [L1+L2+L3+N-PE] (I_{total})	50 kA
Specific energy [L1+L2+L3+N-PE] (W/R)	625.00 kJ/ohms
Lightning impulse current (10/350 μ s) [L-N]/[N-PE] (I_{imp})	12.5 / 50 kA
Specific energy [L-N]/[N-PE] (W/R)	39.06 / 625.00 kJ/ohms
Nominal discharge current (8/20 μ s) [L-N]/[N-PE] (I_n)	12.5 / 50 kA
Voltage protection level [L-N]/[N-PE] (U_p)	≤ 1.5 / ≤ 1.5 kV
Follow current extinguishing capability [L-N]/[N-PE] (I_f)	25 kA _{rms} / 100 A _{rms}
Follow current limitation / Selectivity	no tripping of a 32 A gL/gG fuse up to 25 kA _{rms} (prosp.)
Response time (t_A)	≤ 100 ns
Max. mains-side overcurrent protection	160 A gL/gG
Temporary overvoltage (TOV) [L-N] (U_T) – Characteristic	440 V / 120 min. – withstand
Temporary overvoltage (TOV) [N-PE] (U_T) – Characteristic	1200 V / 200 ms – withstand
Operating temperature range (T_U)	-40 °C ... +80 °C
Operating state / fault indication	green / red
Number of ports	1
Cross-sectional area (L1, L2, L3, N, PE, \oplus) (min.)	1.5 mm ² solid / flexible
Cross-sectional area (L1, L2, L3, N, PE, \oplus) (max.)	35 mm ² stranded / 25 mm ² flexible
For mounting on	35 mm DIN rails acc. to EN 60715
Enclosure material	thermoplastic, red, UL 94 V-0
Place of installation	indoor installation
Degree of protection	IP 20
Capacity	4 module(s), DIN 43880
Approvals	KEMA, VDE, UL
Weight	480 g
Customs tariff number	85363030
GTIN	4013364131798
PU	1 pc(s)

DEHNflex

DFL A 255 (924 389)

- Acoustic fault indication
- Compact design
- For use in flush-mounted systems, cable ducts and flush-type boxes

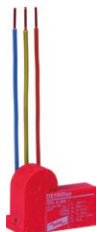
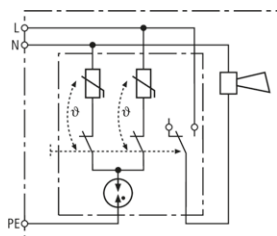
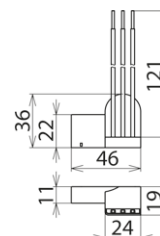

Figure without obligation



Basic circuit diagram DFL A 255



Dimension drawing DFL A 255

Surge arrester for use in all types of installation systems for terminal equipment; with test function

Type	DFL A 255
Part No.	924 389
SPD according to EN 61643-11	Type 3
SPD according to IEC 61643-1/-11	Class III
Nominal a.c. voltage (U_N)	230 V
Max. continuous operating a.c. voltage (U_C)	255 V
Nominal discharge current (8/20 μ s) (I_n)	3 kA
Total discharge current (8/20 μ s) [L+N-PE] (I_{total})	5 kA
Combined impulse (U_{OC})	6 kV
Combined impulse [L+N-PE] ($U_{OC total}$)	10 kV
Voltage protection level [L-N] (U_P)	≤ 1.25 kV
Voltage protection level [L/N-PE] (U_P)	≤ 1.5 kV
Response time [L-N] (t_A)	≤ 25 ns
Response time [L/N-PE] (t_A)	≤ 100 ns
Max. mains-side overcurrent protection	16 A gL/gG or B 16 A
Short-circuit withstand capability for mains-side overcurrent protection with 16 A gL/gG	6 kA _{rms}
Temporary overvoltage (TOV) [L-N] (U_T)	335 V / 5 sec.
Temporary overvoltage (TOV) [L/N-PE] (U_T)	400 V / 5 sec.
Temporary overvoltage (TOV) [L+N-PE] (U_T)	1200 V + U_{CS} / 200 ms
TOV characteristic [L-N]	withstand
TOV characteristic [L/N-PE]	withstand
TOV characteristic [L+N-PE]	safe
Fault indication	acoustic signal on
Number of ports	1
Operating temperature range (T_U)	-25°C...+40°C
Terminal wires	1 mm ² , 120 mm long
Enclosure material	thermoplastic, red, UL 94 V-2
Place of installation	indoor installation
Degree of protection of installed device	IP 20
Dimensions	36 x 46 x 19 mm
Weight	36 g
Customs tariff number	85363010
GTIN	4013364073692
PU	1 pc(s)

DEHNrail

DR M 2P 255 (953 200)

- Two-pole surge arrester consisting of a base element and plug-in protection module
- High discharge capacity due to heavy-duty zinc oxide varistor/spark gap combination
- Energy coordination with other arresters of the Red/Line product family



Figure without obligation

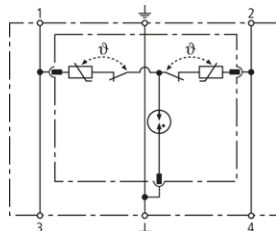

Basic circuit diagram DR M 2P 255

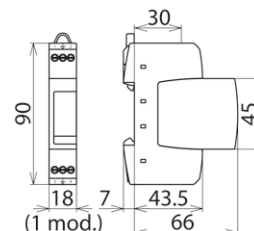

Dimension drawing DR M 2P 255

Two-pole surge arrester consisting of a base part and plug-in protection module

Type	DR M 2P 255
Part No.	953 200
SPD according to EN 61643-11	Type 3
SPD according to IEC 61643-1/-11	Class III
Nominal a.c. voltage (U_N)	230 V
Max. continuous operating a.c. voltage (U_C)	255 V
Max. continuous operating d.c. voltage (U_C)	255 V
Nominal load current a.c. (I_L)	25 A
Nominal discharge current (8/20 μ s) (I_n)	3 kA
Total discharge current (8/20 μ s) [L+N-PE] (I_{total})	5 kA
Combined impulse (U_{OC})	6 kV
Combined impulse [L+N-PE] ($U_{OC total}$)	10 kV
Voltage protection level [L-N] (U_P)	≤ 1250 V
Voltage protection level [L/N-PE] (U_P)	≤ 1500 V
Response time [L-N] (t_A)	≤ 25 ns
Response time [L/N-PE] (t_A)	≤ 100 ns
Max. mains-side overcurrent protection	25 A gL/gG or B 25 A
Short-circuit withstand capability for mains-side overcurrent protection with 25 A gL/gG	6 kA _{rms}
Temporary overvoltage (TOV) [L-N] (U_T)	335 V / 5 sec.
Temporary overvoltage (TOV) [L/N-PE] (U_T)	400 V / 5 sec.
Temporary overvoltage (TOV) [L+N-PE] (U_T)	1200 V + U_{CS} / 200 ms
TOV characteristic [L-N]	withstand
TOV characteristic [L/N-PE]	withstand
TOV characteristic [L+N-PE]	withstand
Operating temperature range (T_U)	-40°C...+80°C
Operating state/fault indication	green / red
Number of ports	1
Cross-sectional area (min.)	0.5 mm ² solid/flexible
Cross-sectional area (max.)	4 mm ² solid/2.5 mm ² flexible
For mounting on	35 mm DIN rails acc. to EN 60715
Enclosure material	thermoplastic, red, UL 94 V-0
Place of installation	indoor installation
Degree of protection	IP 20
Capacity	1 module(s), DIN 43880
Approvals	KEMA, VDE, UL, VdS, CSA
Weight	81 g
Customs tariff number	85363030
GTIN	4013364108301
PU	1 pc(s)

DEHNrail

DR M 4P 255 (953 400)

- Four-pole surge arrester consisting of a base element and plug-in protection module
- High discharge capacity due to heavy-duty zinc oxide varistor/spark gap combination
- Energy coordination with other arresters of the Red/Line product family



Figure without obligation

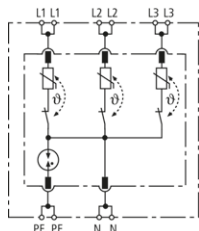

Basic circuit diagram DR M 4P 255

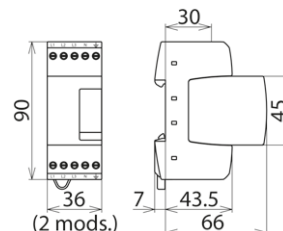

Dimension drawing DR M 4P 255

Four-pole surge arrester consisting of a base part and plug-in protection module; FM version with floating remote signalling contact

Type	DR M 4P 255
Part No.	953 400
SPD according to EN 61643-11	Type 3
SPD according to 61643-1/-11	Class III
Nominal a.c. voltage (U_N)	230/400 V
Max. continuous operating a.c. voltage (U_C)	255/440 V
Nominal load current a.c. (I_L)	25 A
Nominal discharge current (8/20 μ s) (I_n)	3 kA
Total discharge current (8/20 μ s) [L1+L2+L3+N-PE] (I_{total})	8 kA
Combined impulse (U_{OC})	6 kV
Combined impulse [L1+L2+L3+N-PE] ($U_{OC total}$)	16 kV
Voltage protection level [L-N] (U_P)	≤ 1000 V
Voltage protection level [L/N-PE] (U_P)	≤ 1500 V
Response time [L-N] (t_A)	≤ 25 ns
Response time [L/N-PE] (t_A)	≤ 100 ns
Max. mains-side overcurrent protection	25 A gL/gG or B 25 A
Short-circuit withstand capability for mains-side overcurrent protection with 25 A gL/gG	6 kA _{rms}
Temporary overvoltage (TOV) [L-N] (U_T)	335 V / 5 sec.
Temporary overvoltage (TOV) [L/N-PE] (U_T)	400 V / 5 sec.
Temporary overvoltage (TOV) [N-PE] (U_T)	1200 V / 200 ms
TOV characteristic [L-N]	withstand
TOV characteristic [L/N-PE]	withstand
TOV characteristic [L+N-PE]	safe
Operating temperature range (T_U)	-40°C...+80°C
Operating state/fault indication	green / red
Number of ports	1
Cross-sectional area (min.)	0.5 mm ² solid/flexible
Cross-sectional area (max.)	4 mm ² stranded/2.5 mm ² flexible
For mounting on	35 mm DIN rails acc. to EN 60715
Enclosure material	thermoplastic, red, UL 94 V-0
Place of installation	indoor installation
Degree of protection	IP 20
Capacity	2 modules, DIN 43880
Approvals, Certifications	KEMA, VDE, UL
Weight	138 g
Customs tariff number	85363030
GTIN	4013364115767
PU	1 pc(s)

SFL-Protector

SFL PRO 6X (909 250)

- Surge protection with monitoring device and disconnecter
- Interference suppressor filter
- Visual operating state (green) and fault indication (red)



Figure without obligation

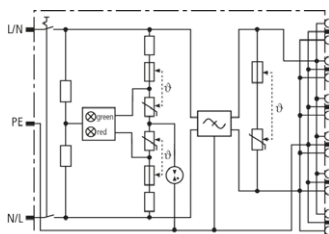

Basic circuit diagram SFL PRO 6X



Dimension drawing SFL PRO 6X

Surge protective multiple socket outlet with mains filter

Type	SFL PRO 6X
Part No.	909 250
SPD according to EN 61643-11	Type 3
SPD according to 61643-1/-11	Class III
Nominal a.c. voltage (U_N)	230 V
Max. continuous operating a.c. voltage (U_C)	255 V
Nominal load current a.c. (I_L)	16 A
Nominal discharge current (8/20 μ s) (I_n)	3 kA
Total discharge current (8/20 μ s) [L+N-PE] (I_{total})	5 kA
Combined impulse (U_{OC})	6 kV
Combined impulse [L+N-PE] ($U_{OC total}$)	10 kV
Voltage protection level (U_P)	≤ 1.5 kV
Response time [L-N] (t_A)	≤ 25 ns
Response time [L/N-PE] (t_A)	≤ 100 ns
Max. mains-side overcurrent protection	16 A gL/gG or B 16 A
Short-circuit withstand capability for mains-side overcurrent protection with 16 A gL/gG	1.5 kA _{rms}
Temporary overvoltage (TOV) [L-N] (U_T)	335 V / 5 sec.
Temporary overvoltage (TOV) [L/N-PE] (U_T)	400 V / 5 sec.
Temporary overvoltage (TOV) [L+N-PE] (U_T)	1200 V + U_{CS} / 200 ms
TOV characteristic [L-N]	withstand
TOV characteristic [L/N-PE]	withstand
TOV characteristic [L+N-PE]	safe
Fault indication	red light
Operating state indication	green light
Number of ports	2
Operating temperature range (T_U)	-20°C...+40°C
Connecting cable	approx. 2000 mm
Number of socket outlets	6
For mounting on	plug-in systems with earth contact according to DIN 49440 / DIN 49441
Enclosure material	thermoplastic, black/silver, UL 94 V-1
Place of installation	indoor installation
Degree of protection	IP 20
Dimensions	571 x 72 x 43 mm
Mains filter	acc. to EN 60939-1
Attenuation for f = 1 MHz, balanced	≥ 32 dB
Attenuation for f = 1 MHz, unbalanced	≥ 30 dB
Weight	1,1 kg
Customs tariff number	85369010
GTIN	4013364132566
PU	1 pc(s)

BLITZDUCTOR XT

BXT ML2 BD 180 (920 247)

- LifeCheck SPD monitoring function
- Optimal protection of one pair
- For installation in conformity with the lightning protection zone concept at the boundaries from 0_A-2 and higher



Figure without obligation

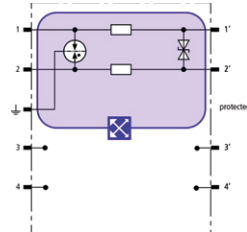

Basic circuit diagram BXT ML2 BD 180

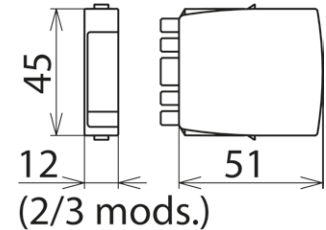

Dimension drawing BXT ML2 BD 180

Space-saving combined lightning current and surge arrester module with LifeCheck feature for protecting one pair of unearthed balanced interfaces. If LifeCheck detects thermal or electrical overload, the arrester has to be replaced. This status is indicated contactlessly by the DEHNrecord LC / SCM / MCM reader.

Type	BXT ML2 BD 180
Part No.	920 247
SPD monitoring system	LifeCheck
SPD class	TYPE 1P2
Nominal voltage (U_N)	180 V
Max. continuous operating d.c. voltage (U_c)	180 V
Max. continuous operating a.c. voltage (U_c)	127 V
Nominal current at 45 °C (I_L)	0.75 A
D1 Total lightning impulse current (10/350 μ s) (I_{imp})	5 kA
D1 Lightning impulse current (10/350 μ s) per line (I_{imp})	2.5 kA
C2 Total nominal discharge current (8/20 μ s) (I_n)	20 kA
C2 Nominal discharge current (8/20 μ s) per line (I_n)	10 kA
Voltage protection level line-line for I_{imp} D1 (U_p)	≤ 270 V
Voltage protection level line-PG for I_{imp} D1 (U_p)	≤ 550 V
Voltage protection level line-line at 1 kV/ μ s C3 (U_p)	≤ 250 V
Voltage protection level line-PG at 1 kV/ μ s C3 (U_p)	≤ 550 V
Series resistance per line	1.8 ohm(s)
Cut-off frequency line-line (f_c)	25.0 MHz
Capacitance line-line (C)	≤ 240 pF
Capacitance line-PG (C)	≤ 16 pF
Operating temperature range (T_U)	-40 °C ... +80 °C
Degree of protection (plugged-in)	IP 20
Pluggable into	BXT BAS / BSP BAS 4 base part
Earthing via	BXT BAS / BSP BAS 4 base part
Enclosure material	polyamide PA 6.6
Colour	yellow
Test standards	IEC 61643-21 / EN 61643-21, UL 497B
SIL classification	up to SIL3 ^{*)}
ATEX approvals	DEKRA 11ATEX0089 X: II 3 G Ex nA IIC T4 Gc
IECEx approvals	DEK 11.0032X: Ex nA IIC T4 Gc
CSA & USA Hazloc approvals (1)	2516389: Class I Div. 2 GP A, B, C, D T4
CSA & USA Hazloc approvals (2)	2516389: Class I Zone 2, AEx nA IIC T4
Approvals	CSA, GOST, VdS
Weight	43 g
Customs tariff number	85363010
GTIN	4013364116078
PU	1 pc(s)

^{*)} For more detailed information, please visit www.dehn-international.com.

BLITZDUCTOR XT

BSP M2 BE HF 5 (926 270)

- High degree of protection for two single lines
- For installation in conformity with the lightning protection zone concept at the boundaries from 0_B-2 and higher



Figure without obligation

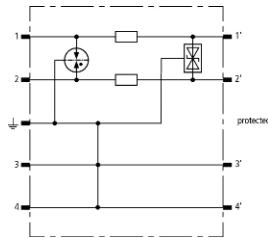

Basic circuit diagram BSP M2 BE HF 5

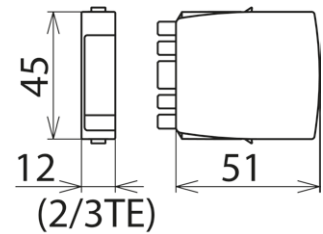

Dimension drawing BSP M2 BE HF 5

Space-saving surge arrester module for protecting two single lines sharing a common reference potential and high-frequency transmission systems without galvanic isolation.

Type	BSP M2 BE HF 5
Part No.	926 270
SPD class	TYPE 2 [21]
Nominal voltage (U_N)	5 V
Max. continuous operating d.c. voltage (U_C)	6.0 V
Max. continuous operating a.c. voltage (U_C)	4.2 V
Nominal current at 45 °C (I_L)	1.0 A
C2 Total nominal discharge current (8/20 μ s) (I_n)	20 kA
C2 Nominal discharge current (8/20 μ s) per line (I_n)	10 kA
Voltage protection level line-line for I_n C2 (U_p)	≤ 31 V
Voltage protection level line-PG for I_n C2 (U_p)	≤ 74 V
Voltage protection level line-line at 1 kV/ μ s C3 (U_p)	≤ 11 V
Voltage protection level line-PG at 1 kV/ μ s C3 (U_p)	≤ 11 V
Series impedance per line	1.0 ohm(s)
Cut-off frequency line-PG (f_c)	100 MHz
Capacitance line-line (C)	≤ 20 pF
Capacitance line-PG (C)	≤ 30 pF
Operating temperature range (T_U)	-40 °C ... +80 °C
Degree of protection (plugged-in)	IP 20
Pluggable into	BXT BAS / BSP BAS 4 base part
Earthing via	BXT BAS / BSP BAS 4 base part
Enclosure material	polyamide PA 6.6
Colour	yellow
Test standards	IEC 61643-21, UL 497B
SIL classification	up to SIL3 *)
Approvals	UL, CSA
Weight	21 g
Customs tariff number	85363010
GTIN	4013364127135
PU	1 pc(s)

*) For more detailed information, please visit www.dehn-international.com.

BLITZDUCTOR XT

BXT BAS (920 300)

- Four-pole version for universal use with all types of BSP and BXT / BXTU protection modules
- No signal interruption if the protection module is removed
- Universal design without protection elements



Figure without obligation

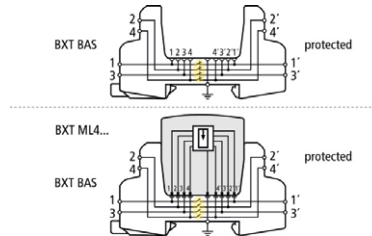

Basic circuit diagram with and without plugged-in module

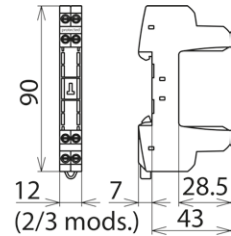

Dimension drawing BXT BAS

The BLITZDUCTOR XT base part is a very space-saving and universal four-pole feed-through terminal for the insertion of a protection module without signal interruption if the protection module is removed. The snap-in mechanism at the supporting foot of the base part allows the protection module to be safely earthed via the DIN rail. Since no components of the protective circuit are situated in the base part, only the protection modules must be maintained.

Type Part No.	BXT BAS 920 300
Operating temperature range (T _U)	-40 °C ... +80 °C
Degree of protection	IP 20
For mounting on	35 mm DIN rails acc. to EN 60715
Connection (input / output)	screw / screw
Signal disconnection	no
Cross-sectional area, solid	0.08-4 mm ²
Cross-sectional area, flexible	0.08-2.5 mm ²
Tightening torque (terminals)	0.4 Nm
Earthing via	35 mm DIN rails acc. to EN 60715
Enclosure material	polyamide PA 6.6
Colour	yellow
ATEX approvals	DEKRA 11ATEX0089 X: II 3 G Ex nA IIC T4 Gc ^{*)}
IECEx approvals	DEK 11.0032X: Ex nA IIC T4 Gc ^{*)}
Approvals	CSA, VdS, UL, GOST
Weight	34 g
Customs tariff number	85369010
GTIN	4013364109179
PU	1 pc(s)

^{*)} only in connection with an approved protection module

DEHNbox

DBX TC 180 (922 210)

- Powerful protection for telecommunication interfaces
- Suitable for wall mounting, IP 65
- Installation in conformity with the lightning protection zone concept at the boundaries from $0_A - 2$ and higher



Figure without obligation

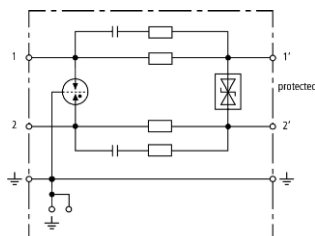

Basic circuit diagram DBX TC 180

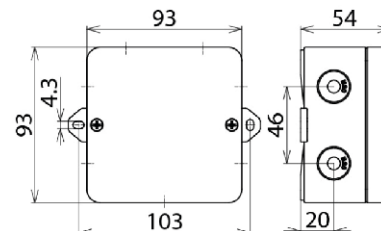

Dimension drawing DBX TC 180

Compact combined arrester in a surface-mounted plastic enclosure for protecting information technology interfaces, particularly telecommunication connections and devices such as analogue telephone, ISDN and xDSL (VDSL2-tested). Fast connection of one pair without tools and integrated strain relief for the connecting cable. Cut-off frequency up to 250 MHz ensures maximum transmission performance in case of high-frequency signal parts.

Type Part No.	DBX TC 180 922 210
SPD class	TYPE P2
Nominal voltage (U_N)	180 V
Max. continuous operating d.c. voltage (U_C)	180 V
Max. continuous operating a.c. voltage (U_C)	127 V
Nominal current at 45°C (I_L)	0.75 A
D1 Total lightning impulse current (10/350 μ s) (I_{imp})	7.5 kA
D1 Lightning impulse current (10/350 μ s) per line (I_{imp})	2.5 kA
C2 Total nominal discharge current (8/20 μ s) (I_n)	15 kA
C2 Nominal discharge current (8/20 μ s) per line (I_n)	7.5 kA
Voltage protection level line-line at 1 kV/ μ s C3 (U_p)	≤ 250 V
Voltage protection level line-PG at 1 kV/ μ s C3 (U_p)	≤ 550 V
Voltage protection level line-line for I_{imp} D1 (U_p)	≤ 300 V
Voltage protection level line-PG for I_{imp} D1 (U_p)	≤ 550 V
Series resistance per line	1.8 ohms
Bandwidth line-line (100 ohms) (f_c)	250 MHz
Capacitance line-line (C)	≤ 20 pF
Capacitance line-PG (C)	≤ 10 pF
Operating temperature range (T_U)	-25 °C ... +40 °C
Degree of protection	IP 65
Cross-sectional area of the signal lines, solid	0.2-1.5 mm ²
Cross-sectional area of the signal lines, flexible	0.25-1.5 mm ²
Cross-sectional area of the earth terminal	0.25-2.5 mm ²
Dimensions (L x W x H)	93 x 93 x 55 mm
Enclosure material	polycarbonate
Colour	grey
Test standards	IEC 61643-21 / EN 61643-21
Weight	138 g
Customs tariff number	85363010
GTIN	4013364158214
PU	1 pc(s)

DEHNpatch

DPA M CLE RJ45B 48 (929 121)

- Ideally suited for retrofitting, protection of all lines
- Cat. 6 in the channel (class E)
- Power over Ethernet (PoE+ according to IEEE 802.3at)
- For installation in conformity with the lightning protection zone concept at the boundaries from $0_B -2$ and higher



Figure without obligation

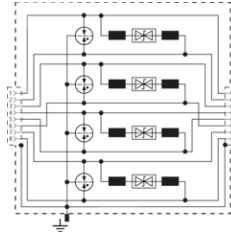

Basic circuit diagram DPA CLE RJ45B 48

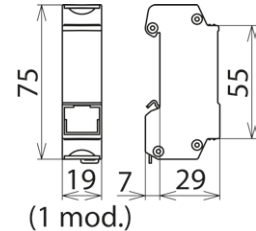

Dimension drawing DPA CLE RJ45B 48

Universal arrester for Industrial Ethernet, Power over Ethernet (PoE+ acc. to IEEE 802.3at up to 57 V) and similar applications in structured cabling systems according to class E up to 250 MHz. Protection of all pairs by means of powerful gas discharge tubes and one adapted filter matrix per pair. Fully shielded type with sockets for DIN rail mounting (up to 1 Gbit Ethernet).

Accessories: Earthing bracket with flat connector sleeve

Type	DPA M CLE RJ45B 48
Part No.	929 121
SPD class	TYPE 2 Pt
Nominal voltage (U_N)	48 V
Max. continuous operating d.c. voltage (U_c)	48 V
Max. continuous operating a.c. voltage (U_c)	34 V
Max. continuous operating d.c. voltage pair-pair (PoE) (U_c)	57 V
Nominal current (I_L)	1 A
D1 Lightning impulse current (10/350 μ s) per line (I_{imp})	0.5 kA
C2 Nominal discharge current (8/20 μ s) line-line (I_n)	150 A
C2 Nominal discharge current (8/20 μ s) line-PG (I_n)	2.5 kA
C2 Total nominal discharge current (8/20 μ s) line-PG (I_n)	10 kA
C2 Nominal discharge current (8/20 μ s) pair-pair (PoE) (I_n)	150 A
Voltage protection level line-line for I_n C2 (U_p)	≤ 180 V
Voltage protection level line-PG for I_n C2 (U_p)	≤ 500 V
Voltage protection level line-line for I_n C2 (PoE) (U_p)	≤ 600 V
Voltage protection level line-line at 1 kV/ μ s C3 (U_p)	≤ 180 V
Voltage protection level line-PG at 1 kV/ μ s C3 (U_p)	≤ 500 V
Voltage protection level pair-pair at 1 kV/ μ s C3 (PoE) (U_p)	≤ 600 V
Insertion loss at 250 MHz	≤ 3 dB
Capacitance line-line (C)	≤ 30 pF
Capacitance line-PG (C)	≤ 25 pF
Operating temperature range (T_U)	-40 °C ... +80 °C
Degree of protection	IP 10
For mounting on	35 mm DIN rails acc. to EN 60715
Connection (input / output)	RJ45 socket / RJ45 socket
Pinning	1/2, 3/6, 4/5, 7/8
Earthing via	35 mm DIN rail acc. to EN 60715
Enclosure material	zinc die-casting
Colour	bare surface
Test standards	IEC 61643-21 / EN 61643-21
Approvals	CSA, UL, GOST
Accessories	fixing material
Weight	123 g
Customs tariff number	85366910
GTIN	4013364118935
PU	1 pc(s)

www.dehn-international.com/partners



**Surge Protection
Lightning Protection
Safety Equipment
DEHN protects.**

DEHN + SÖHNE
GmbH + Co.KG.

Hans-Dehn-Str. 1
Postfach 1640
92306 Neumarkt
Germany

Tel. +49 9181 906-0
Fax +49 9181 906-1100
info@dehn.de
www.dehn-international.com



www.dehn-international.com/partners

Type designations of products mentioned in the white paper being at the same time registered trademarks are not especially marked. So if there is no marking of TM or © this does not mean that the type designation is a free trade name. Neither it can be seen whether patents or utility models and other intellectual and industrial property rights are available. We reserve the right to introduce changes in performance, configuration and technology, dimensions, weights and materials in the course of technical progress. The figures are shown without obligation. Misprints, errors and modifications excepted. Reproduction in any form whatsoever is forbidden without our authorisation.

actiVsense, BLITZDUCTOR, BLITZPLANER, DEHN, DEHN Logo, DEHN schützt, DEHNbloc, DEHNfix, DEHNgrip, DEHNguard, DEHNport, DEHNQUICK, DEHNrapid, DEHNshield, DEHNSnap, DEHNventil, HVI, LifeCheck, Red/Line are protected by German Trade Mark, by Community Trade Mark (EU) and/or in other countries.