



White Paper

Lightning and surge protection for wind turbines



Contents

- Lightning protection zone concept
- Shielding measures
- External and internal lightning protection measures
- Earth-termination system
- Selection of SPDs based on the voltage protection level (U_p) and the immunity of the equipment
- Protection of power supply and information technology systems
- Protection of the generator lines and the pitch system
- Condition monitoring
- Laboratory tests

White Paper

Lightning and surge protection for wind turbines



Due to their exposed location and height, wind turbines are vulnerable to the effects of direct lightning strikes. Several studies have shown that at least 10 direct lightning strikes to wind turbines in the multimewatt range have to be expected every year. The feed-in compensation must amortise the high investment costs within a few years, meaning that downtime caused by lightning and surge damage and the resulting repair costs must be avoided. For this reason, comprehensive lightning and surge protection measures are required. When planning lightning protection measures, not only cloud-to-earth flashes, but also earth-to-cloud flashes, so-called upward leaders, must be considered for objects at exposed locations with a height of more than 60 m. The high electric charge of these upward leaders must be particularly observed for the protection of the rotor blades and for the design of the lightning current arresters.

Standardisation

The IEC 61400-24 standard, the IEC 62305 (EN 62305) standard series and the guidelines by Germanischer Lloyd (e.g. GL 2010 IV – Part 1: Guideline for the certification of wind turbines) form the basis for the protection concept.

Protection measures

The IEC 61400-24 standard and GL 2010 recommend to protect all sub-components of the lightning protection system of a wind turbine according to lightning protection level (LPL) I unless a risk analysis demonstrates that a lower LPL is sufficient. A risk analysis may also reveal that different sub-components have different LPLs. The IEC 61400-24 standard recommends a comprehensive lightning protection concept.

Lightning protection (LP) for a wind turbine consists of an external lightning protection system (LPS) and surge protection measures (SPMs) for protecting electrical and electronic equipment. In order to plan protection measures, it is advisable to subdivide the wind turbine into lightning protection zones (LPZs).

The lightning protection system of a wind turbine protects two sub-systems which can only be found in wind turbines, namely the rotor blades and the mechanical drive train. The IEC 61400-24 standard describes in detail how to protect these special parts of a wind turbine and how to prove the effectiveness of the lightning protection measures. The standard recommends to verify the lightning current withstand capability of these systems in high-current tests with the first stroke and the long stroke, if possible, in a common discharge.

In the following, it will be described how to implement lightning and surge protection measures for electrical and electronic devices/systems of a wind turbine. The complex problems concerning the protection of the rotor blades and rotably mounted parts/bearings must be examined in detail and depend on the manufacturer and type. The IEC 61400-24 standard provides important information in this respect.

Lightning protection zone concept

The lightning protection zone concept is a structuring measure for creating a defined EMC environment in an object. This defined EMC (EMC – Electromagnetic compatibility) environment depends on the immunity of the electrical equipment used. The lightning protection zone concept allows to reduce conducted and field-bound interference at the boundaries to defined values. For this reason, the object to be protected is subdivided into protection zones.

The rolling sphere method is used to determine LPZ O_A , namely the parts of a wind turbine which may be subjected to direct lightning strikes, and LPZ O_B , namely the parts of a wind turbine which are protected from direct lightning strikes by external air-termination systems or air-termination systems integrated in parts of a wind turbine (for example in the rotor blade). According to the IEC 61400-24 standard, the rolling sphere method must not be used for the rotor blade itself. For this reason, the design of the air-termination system should be tested according to subsection 8.2.3 of the IEC 61400-24 standard.

Figure 1 shows a typical application of the rolling sphere method, **Figure 4** the possible division of a wind turbine into different lightning protection zones. In this context, the division of a wind turbine into lightning protection zones depends on the design of the wind turbine. Therefore, the structure of the wind turbine should be observed. However, it is decisive that the lightning parameters injected into LPZ O_A from the outside are reduced by suitable shielding measures and surge protective devices at all zone boundaries so that the electrical and electronic devices and systems inside a wind turbine are not interfered with.

Shielding measures

The nacelle should be designed as a closed metal shield. Thus, a volume with an electromagnetic field that is considerably lower than the field outside the wind turbine is generated in the nacelle. In accordance with IEC 61400-24, a tubular steel tower, which is frequently used for large wind turbines, can be regarded as an almost perfect Faraday cage for electromagnetic shielding. In case of concrete hybrid towers, the function of the galvanic cage must be ensured by reinforcing steel as well as earthing and electrical connection of the individual components. The switchgear and control cabinets in the nacelle and, if any, in the operations building should also be made of metal. The connecting cables should feature an external shield that is capable of carrying lightning currents. Shielded cables are only resistant to EMC interference if the shields are connected to the equipotential bonding system on both ends. The shields must be contacted by means of fully (360°) contacting terminals to prevent EMC-incompatible, long connecting cables in the wind turbine.

Magnetic shielding and cable routing should be performed as per section 4 of IEC 62305-4 (EC 62305-4). For this reason, the

White Paper

Lightning and surge protection for wind turbines

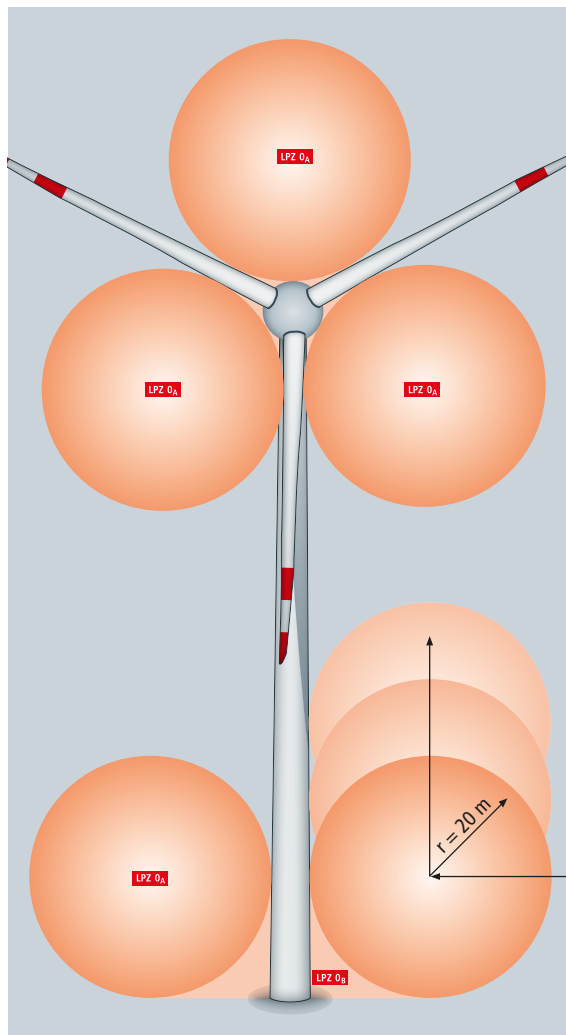

Figure 1 Rolling sphere method

general guidelines for an EMC-compatible installation practice according to IEC/TR 61000-5-2 should be observed.

Shielding measures include for example:

- ➔ Installation of a metal braid on GRP-coated nacelles
- ➔ Metal tower
- ➔ Metal switchgear cabinet
- ➔ Metal control cabinets
- ➔ Lightning current carrying, shielded connecting cables (metal cable duct, shielded pipe or the like)
- ➔ Cable shielding

External lightning protection measures

These include:

- ➔ Air-termination and down-conductor systems in the rotor blades
- ➔ Air-termination systems for protecting nacelle superstructures, the nacelle and the hub
- ➔ Using the tower as air-termination system and down conductor
- ➔ Earth-termination system consisting of a foundation earth electrode and a ring earth electrode

The function of an external lightning protection system (LPS) is to intercept direct lightning strikes including lightning strikes to the tower of a wind turbine and to discharge the lightning current from the point of strike to the ground. An external lightning protection system is also used to distribute the lightning current in the ground without causing thermal or mechanical damage or dangerous sparking which may lead to fire or explosion and endanger persons.

The rolling sphere method can be used to determine potential points of strike for a wind turbine (except for the rotor blades) (Figure 1). For wind turbines, it is recommended to use class of LPS I. Therefore, a rolling sphere with a radius $r = 20$ m is rolled over the wind turbine to determine the points of strike. Air-termination systems are required where the sphere touches the wind turbine (potential points of strike).

The nacelle construction should be integrated in the lightning protection system to ensure that lightning strikes to the nacelle hit either natural metal parts that are capable of withstanding this stress or an air-termination system designed for this purpose. GRP-coated nacelles or the like should be fitted with an air-termination system and down conductors forming a cage around the nacelle (metal braid). The air-termination system including the bare conductors in this cage should be capable of withstanding lightning strikes according to the relevant lightning protection level. Other conductors in the Faraday cage should be designed in such a way that they withstand the amount of lightning current to which they may be subjected. The IEC 61400-24 standard requires that air-termination systems for protecting measurement equipment etc. mounted outside the nacelle be designed in compliance with the general requirements of IEC 62305-3 (EN 62305-3) and that down conductors be connected to the cage described above.

Natural components made of conductive materials which are permanently installed in/on a wind turbine and remain unchanged (e.g. lightning protection system of the rotor blades, bearings, mainframes, hybrid tower) may be integrated in the LPS. If wind turbines consist of a metal construction, it can be assumed that they fulfil the requirements for an external

White Paper

Lightning and surge protection for wind turbines



lightning protection system of class of LPS I according to IEC 62305 (EN 62305).

This requires that the lightning strike be safely intercepted by the lightning protection system of the rotor blades so that it can be discharged to the earth-termination system via the natural components such as bearings, mainframes, the tower and/or bypass systems (e.g. open spark gaps, carbon brushes).

Air-termination system/ down conductor

As can be seen in **Figure 1**, the

- ➔ Rotor blades,
- ➔ Nacelle including superstructures (**Figures 2 and 4**),
- ➔ Rotor hub and
- ➔ Tower of the wind turbine

may be hit by lightning. If they are capable of safely intercepting the maximum lightning impulse current of 200 kA and to discharge it to the earth-termination system, they can be used as natural components of the air-termination system of the wind turbine's external lightning protection system.

A metallic receptor, which represents a defined point of strike for flashes, is frequently attached to the tip of the GRP blade to protect the rotor blades from lightning strikes. A down conductor is routed from the receptor to the blade root. In case of a lightning strike, it can be assumed that lightning hits the blade tip (receptor) and then travels through the down conductor inside the blade via the nacelle and the tower to the earth-termination system.

Earth-termination system

The earth-termination system of a wind turbine must perform several functions such as personal protection, EMC protection and lightning protection.

An effective earth-termination system (**Figure 3**) is essential to distribute lightning currents and to prevent that the wind turbine is destroyed. Moreover, the earth-termination system must protect persons and animals against electric shock. In case of a lightning strike, the earth-termination system must discharge high lightning currents to the ground and distribute them in the ground without causing dangerous thermal and/or electrodynamic effects.

In general, it is important to install an earth-termination system for a wind turbine which is used to protect the wind turbine against lightning strikes and to earth the power supply system.

Note: Electrical high-voltage regulations such as CENELEC HO 637 S1 or applicable national standards describe how to design an earth-termination system to prevent high touch and step voltages caused by short-circuits in high or medium-voltage systems. With regard to the protection of persons, the IEC 61400-24 standard refers to IEC/TS 60479-1 and IEC 60479-4.

Arrangement of earth electrodes

The IEC 62305-3 (EN 62305-3) standard describes two basic types of earth electrode arrangements for wind turbines:

Type A: According to the informative Annex I of IEC 61400-24, this arrangement must not be used for wind turbines, but for adjoining building of wind turbines (for example buildings containing measurement equipment or office sheds of a wind farm). Type A earth electrode arrangements consist of horizontal or vertical earth electrodes connected to the building by at least two down conductors.

Type B: According to the informative Annex I of IEC 61400-24, type B earth electrodes must be used for wind turbines. They either consist of a buried external ring earth electrode and/or a foundation earth electrode. Ring earth electrodes and metal parts in the foundation must be connected to the tower construction.

In any case, the reinforcement of the tower foundation should be integrated in the earth-termination system of a wind turbine. To ensure an earth-termination system ranging over as large an area as possible, the earth-termination system of the tower base and the operations building should be connected by means of a meshed earth electrode network. Corrosion-resistant ring earth electrodes (made of stainless steel (V4A), e.g. material No. AISI/ASTM 316 Ti) with potential control prevent excessive step voltages in case of a lightning strike and must be installed around the tower base to ensure personal protection (**Figure 3**).

Foundation earth electrodes

Foundation earth electrodes make technical and economic sense and are required in the German Technical Connection Conditions (TAB) published by German distribution network



Figure 2 Example of an air-termination system for the weather station and the aircraft warning light

White Paper

Lightning and surge protection for wind turbines



operators. They are part of the electrical installation and fulfil essential safety functions. For this reason, they must be installed by electrically skilled persons or under supervision of an electrically skilled person.

The metals used for earth electrodes must comply with the materials listed in Table 7 of IEC 62305-3 (EN 62305-3). The corrosion behaviour of metal in the ground must be observed at any time.

Foundation earth electrodes must be made of galvanised or non-galvanised (round or strip) steel. Round steel must have a minimum diameter of 10 mm, while strip steel must have minimum dimensions of 30 mm x 3.5 mm. It must be observed that this material must be covered with a concrete layer of at least

5 cm (corrosion protection). The foundation earth electrode must be connected to the main earthing busbar in the wind turbine. Corrosion-resistant connections must be established via fixed earthing terminals or terminal lugs made of stainless steel (V4A). Moreover, a ring earth electrode made of stainless steel (V4A) must be installed in the ground.

Internal lightning protection measures

- ➔ Earthing and equipotential bonding measures
- ➔ Spatial shielding and separation distance
- ➔ Cable routing and cable shielding
- ➔ Installation of coordinated surge protective devices

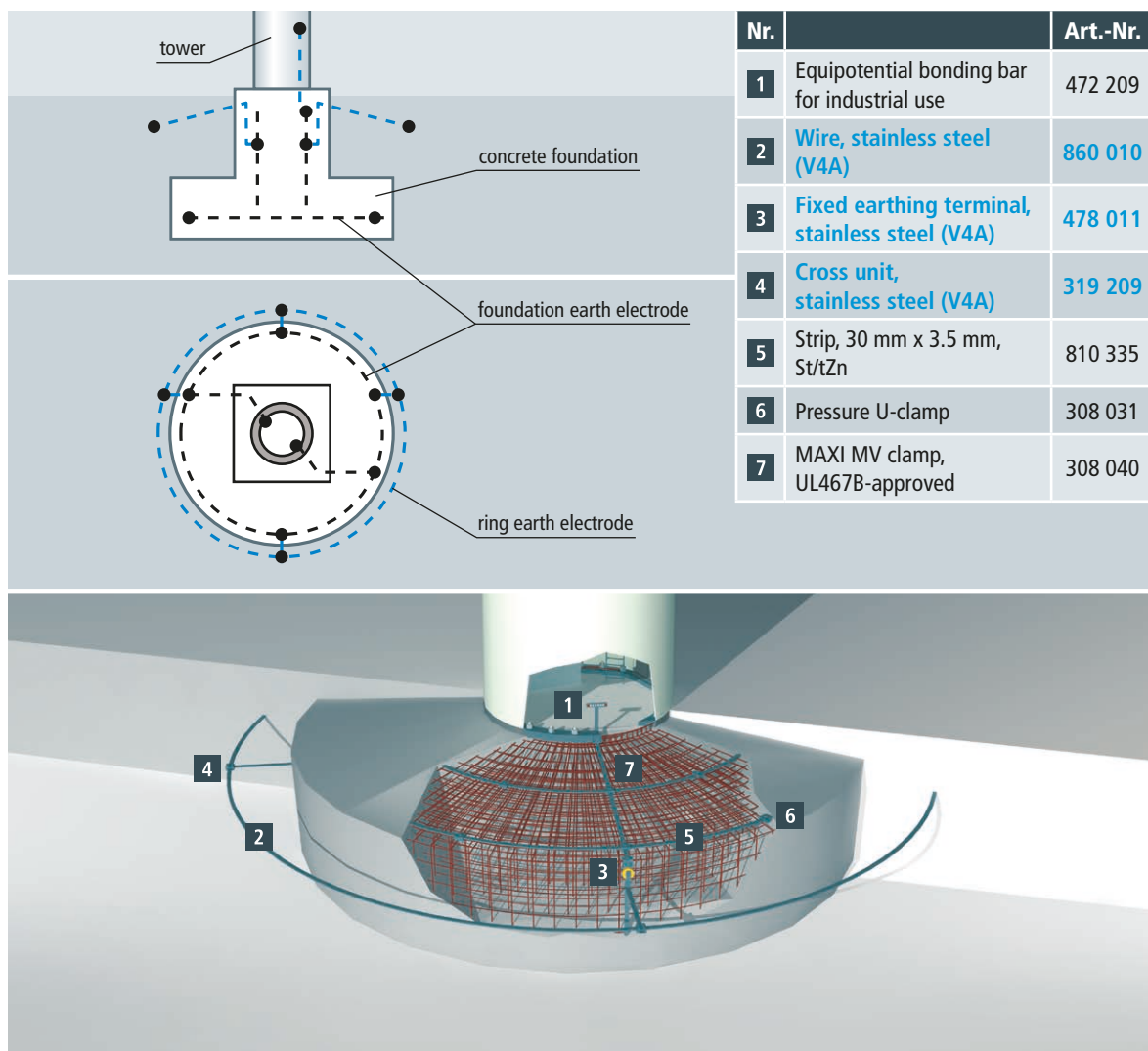

Figure 3 Earth-termination system of a wind turbine

White Paper

Lightning and surge protection for wind turbines



Protection of the lines at the transition from LPZ 0_A to LPZ 1 and higher

To ensure safe operation of electrical and electronic devices, the boundaries of the lightning protection zones (LPZs) must be shielded against field-based interference and must be protected against conducted interference (**Figures 4 and 5**). To this end, surge protective devices that are capable of discharging high partial lightning currents without destruction must be installed at the transition from LPZ 0_A to LPZ 1 (also referred to as lightning equipotential bonding). These surge protective devices are referred to as type 1 lightning current arresters and are tested by means of impulse currents of 10/350 μ s waveform. At the transition from LPZ 0_B to LPZ 1 and higher only low-energy impulse currents caused by voltages induced on the system or surges generated in the system must be coped with. These surge protective devices are referred to as type 2 surge arresters and are tested by means of impulse currents of 8/20 μ s waveform.

According to the lightning protection zone concept, all incoming cables and lines must be integrated in the lightning equipotential bonding system by means of type 1 lightning current arresters at the boundary from LPZ 0_A to LPZ 1 or from LPZ 0_A to LPZ 2. This affects both power supply and communication lines. An additional local equipotential bonding system where all ca-

bles and lines entering this boundary are integrated must be established for every further zone boundary within the volume to be protected. Type 2 surge arresters must be installed at the transition from LPZ 0_B to LPZ 1 and from LPZ 1 to LPZ 2, whereas type 3 surge arresters must be provided at the transition from LPZ 2 to LPZ 3. The function of type 2 and type 3 surge arresters is to further reduce the residual interference of the upstream protection stages and to limit the surges induced on the wind turbine or generated in the wind turbine.

Selection of SPDs based on the voltage protection level (U_p) and the immunity of the equipment

To describe the required voltage protection level U_p in an LPZ, the immunity levels of the equipment located in an LPZ must be defined, e.g. for power lines and connections of equipment according to IEC 61000-4-5 and IEC 60664-1, for telecommunication lines and connections of equipment according to IEC 61000-4-5, ITU-T K.20 and ITU-T K.21 and for other lines and connections of equipment according to the manufacturer's instructions. Manufacturers of electrical and electronic components or devices should be able to provide the required information on the immunity level according to the EMC standards. If this is not the case, the wind turbine manufacturer should perform tests to determine the immunity level. The specific

No. in Fig. 4	Area to be protected	Surge protective device	Part No.
1	Voltage supply of the hub Signal lines between the nacelle and the hub	DEHNgard TN 275 FM BLITZDUCTOR XT BE 24 * DENHpatch DPA M CAT6 RJ45S48	952 205 920 324 929 121
2	Protection of the aircraft warning light	DEHNgard M TN 275 FM	952 205
3	Signal lines of the weather station and the control cabinet in the nacelle	BLITZDUCTOR XT ML4 BE 24 * BLITZDUCTOR XT ML2 BE S 24 *	920 324 920 224
4	Control cabinet in the nacelle 230/400 V voltage supply	DEHNgard M TNC 275 FM DEHNgard M TNC CI 275 FM	952 305 952 309
5	Protection of the generator	DEHNgard M WE 600 FM	952 307
6	Protection of the transformer	DEHNmid DMI 9 10 1 DEHNmid DMI 36 10 1	990 003 990 013
7	Voltage supply of the control cabinet in the tower base, 230/400 V TN-C system	DEHNgard M TNC 275 FM DEHNgard M TNC CI 275 FM	952 305 952 309
8	Main incoming supply, 400/690 V TN system	3x DEHNbloc M 1 440 FM	961 145
9	Protection of the inverter	DEHNgard M WE 600 FM	952 307
10	Protection of the signal lines in the control cabinet of the tower base	BLITZDUCTOR XT ML4 BE 24 * BLITZDUCTOR XT ML2 BE S 24 *	920 324 920 224
11	Protection of the nacelle superstructures	Air-termination rods Pipe clamp for air-termination rods	103 449 540 105

Table 1 Protection of a wind turbine (lightning protection zone concept according to **Figure 4**) * associated base part: BXT BAS, Part No. 920 300

White Paper

Lightning and surge protection for wind turbines

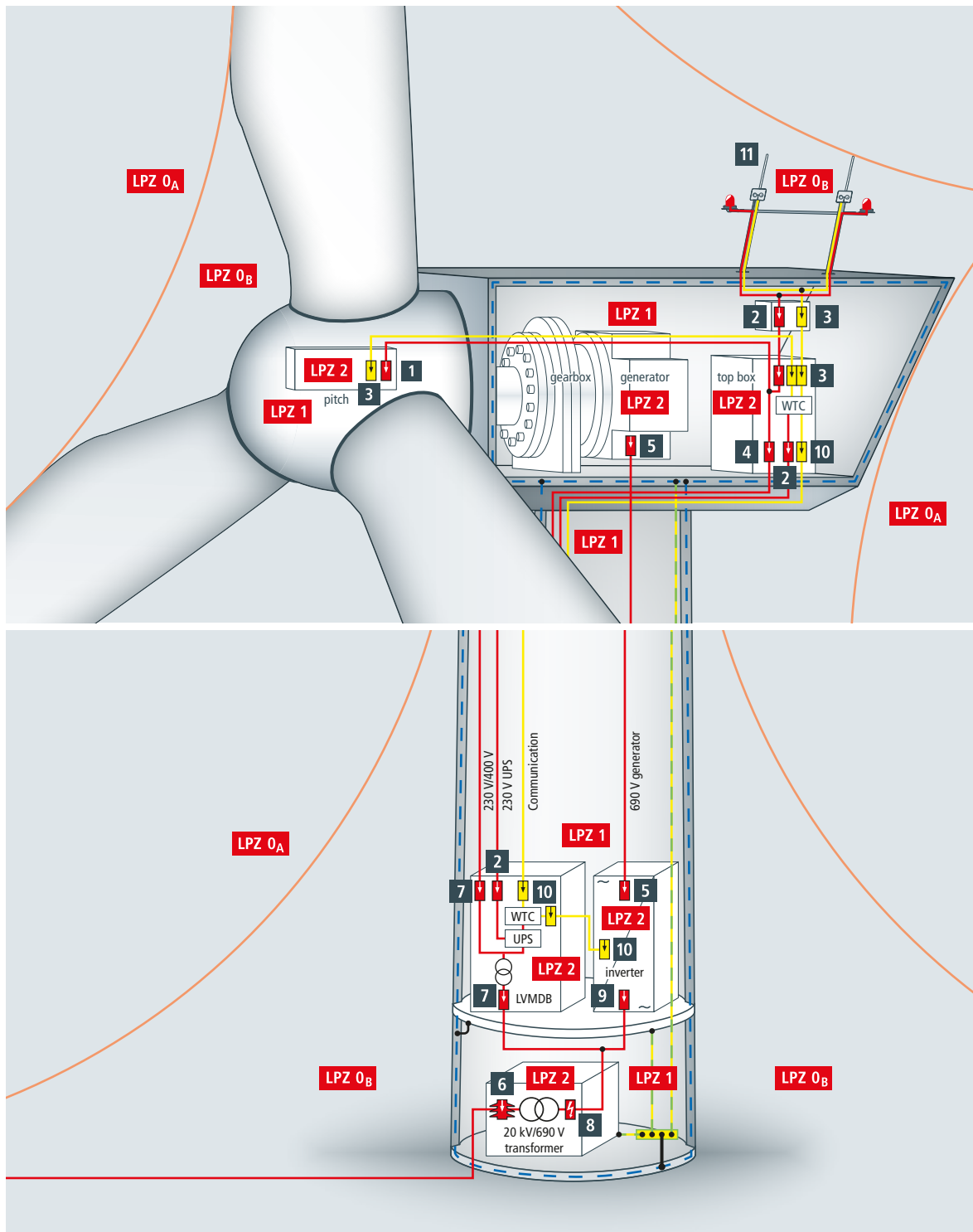

Figure 4 Lightning and surge protection for a wind turbine

White Paper

Lightning and surge protection for wind turbines



immunity level of components in an LPZ directly defines the voltage protection level required at the LPZ boundaries. The immunity of a system must be proven, where applicable, with all SPDs installed and the equipment they are supposed to protect.

Protection of power supply systems

The transformer of a wind turbine may be housed at different locations (in a separate distribution station, in the tower base, in the nacelle). In case of large wind turbines, for example, the unshielded 20 kV cable in the tower base is routed to the medium-voltage switchgear installation consisting of a vacuum circuit breaker, mechanically locked selector switch disconnector, outgoing earthing switch and protective relay. The medium-voltage cables are routed from the medium-voltage switchgear installation in the tower of the wind turbine to the transformer which may be situated in the tower base or in the nacelle (Figure 4). The transformer feeds the control cabinet in the tower base, the switchgear cabinet in the nacelle and the pitch system in the hub by means of a TN-C system (L1, L2, L3, PEN conductor). The switchgear cabinet in the nacelle supplies the electrical equipment in the nacelle with an a.c. voltage of 230/400 V.

According to IEC 60364-4-44, all pieces of electrical equipment installed in a wind turbine must have a specific rated impulse withstand voltage according to the nominal voltage of the wind

turbine (see IEC 60664-1: Table 1, insulation coordination). This means that the surge arresters to be installed must have at least the specified voltage protection level according to the nominal voltage of the wind turbine. Surge arresters used to protect the 400/690 V supply must have a minimum voltage protection level $U_p \leq 2.5$ kV, whereas surge arresters used to protect the 230/400V supply must have a voltage protection level $U_p \leq 1.5$ kV to ensure protection of sensitive electrical/electronic equipment (Figures 6 and 7).

Surge protective devices for the 400/690 V supply shall be capable of discharging lightning currents of 10/350 μ s waveform without destruction and shall have a voltage protection level of $U_p \leq 2.5$ kV (Figure 8).

Protection of the transformer infeed

The medium-voltage transformer infeed is protected by DEHNmid medium-voltage arresters which must be adapted to the system configuration and voltage of the medium-voltage system (Figure 9).

230/400 V supply

Type 2 surge arresters, for example DEHNguard MTNC275 C1FM, should be used to protect the voltage supply of the control cabinet in the tower base, the switchgear cabinet in the nacelle and the pitch system in the hub by means of a 230/400 V TN-C system (Figure 6).

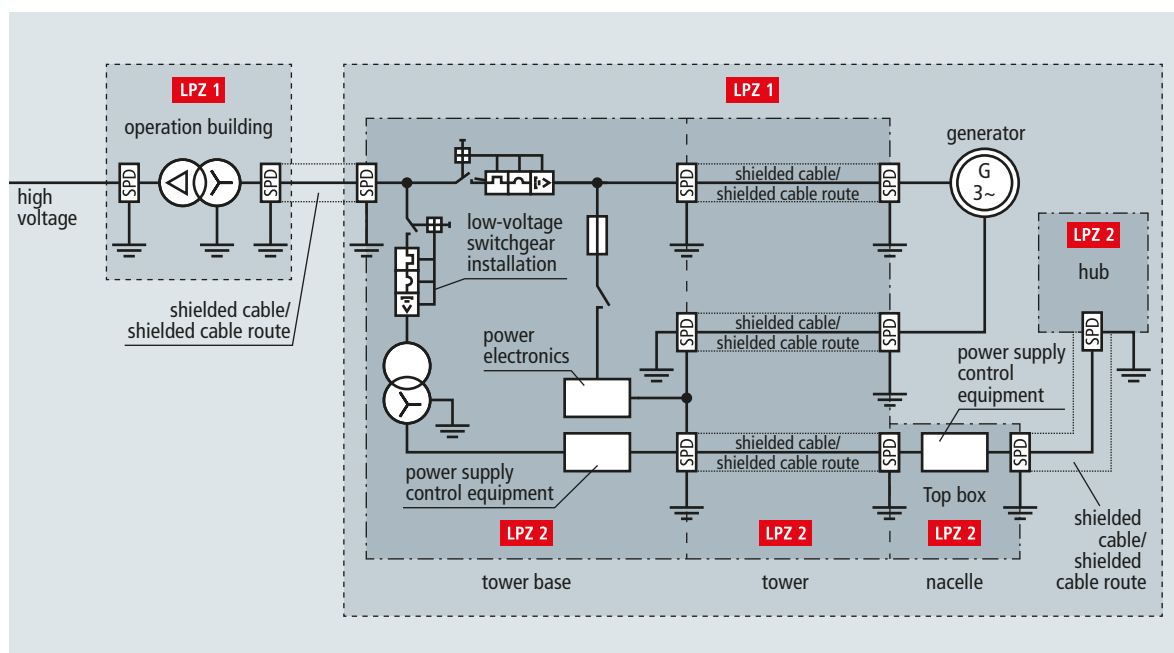

Figure 5 Example of arresters installed at the zone boundaries of a wind turbine according to IEC 61400-24

White Paper

Lightning and surge protection for wind turbines



Figure 6 Modular type 2 surge arrester for protecting the 230/400 V supply

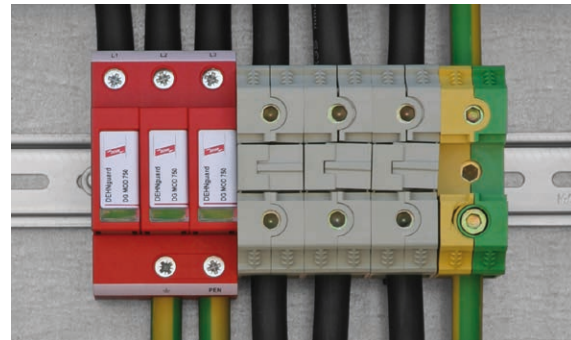

Figure 7 Protection of the generator / inverter



Figure 8 Coordinated type 1 surge arrester



Figure 9 DEHNmid medium-voltage arresters installed in a transformer for wind turbines

Protection of the aircraft warning light

The aircraft warning light on the sensor mast in LPZ 0_B should be protected by a type 2 surge arrester at the relevant zone transitions (LPZ 0_B → 1, LPZ 1 → 2) (Table 1). Depending on the system, e.g. components of the DEHNguard series (low voltage) and/or BLITZDUCTOR family can be used for extra low voltage/signal lines.

400/690 V system

Coordinated single-pole lightning current arresters with a high follow current limitation for the 400/690 V systems, for example DEHNbloc M 1 440 FM (Figure 8), must be installed to protect the 400/690 V transformer, inverters, mains filters and the measurement equipment. It must be ensured at the frequency converter that the arresters are dimensioned for the maximum voltage peaks, which are higher than in case of pure sinusoidal voltages. In this context, surge arresters with a nominal voltage of 600 V and $U_{mov} = 750$ V have proven their worth. The DEHNguard DG M WE 600 FM (Figure 7) arresters can be installed at both sides of the converter (grid and machine side) and on the generator. Only if doubly-fed induction generators are used, an arrester combination with

an increased electric strength must be used on the rotor side. For this purpose, it is advisable to install a 3+1 Neptune circuit with a nominal voltage up to 1000 V. An additional spark-gap-based arrester ensures electrical isolation and prevents premature tripping of the varistors.

Surge arresters for information technology systems

Surge arresters for protecting electronic equipment in telecommunication and signalling networks against the indirect and direct effects of lightning strikes and other transients are described in IEC 61643-21 and are installed at the zone boundaries in conformity with the lightning protection zone concept (Figure 4, Table 1). Multi-stage arresters must be designed without blind spots, in other words it must be ensured that the different protection stages are coordinated with one another. Otherwise not all protection stages will be activated, thus causing faults in the surge protective device. Glass fibre cables are frequently used for routing information technology lines into a wind turbine and for connecting the control cabinets in the tower base to the nacelle. Shielded copper cables are used to connect the actuators and sensors with the control cabinets. Since interference by an electromagnetic environment is ex-

White Paper

Lightning and surge protection for wind turbines



cluded, the glass fibre cables do not have to be protected by surge arresters unless they have a metal sheath which must be integrated in the equipotential bonding system either directly or by means of surge protective devices.

In general, the following shielded signal lines connecting the actuators and sensors with the control cabinets must be protected by surge protective devices:

- ➔ Signal lines of the weather station and the aircraft warning light on the sensor mast
- ➔ Signal lines routed between the nacelle and the pitch system in the hub
- ➔ Signal lines for the pitch system
- ➔ Signal lines to the inverter
- ➔ Signal lines to the fire extinguishing system

Signal lines of the weather station

The signal lines (4–20 mA interfaces) between the sensors of the weather station and the switchgear cabinet are routed from LPZ 0_B to LPZ 2 and can be protected by means of BLITZDUCTOR XT ML4 BE 24 or BLITZDUCTOR XT ML2 BE S 24 combined arresters (**Figure 10**). These space-saving combined arresters with LifeCheck feature protect two or four single cores sharing a common reference potential as well as unbalanced interfaces and are available with direct or indirect shield earthing. Shield terminals with a flexible spring element for permanent low-impedance shield contact with the protected and unprotected side of the arrester are used for earthing the shield.

If the wind measurement equipment (anemometer) is fitted with a heating system, BLITZDUCTOR BVT ALD 36 combined arresters may be installed. These DIN rail mounted combined arresters are energy-coordinated with the surge protective devices of unearthed d.c. power supply systems (**Figure 10**).

Signal lines for the pitch system

An universal DEHNpatch DPA M CLE RJ45B 48 surge arrester can be used if information between the nacelle and the pitch system is exchanged via 100 MB Ethernet data lines. This arrester is designed for Industrial Ethernet and similar applications in structured cabling systems according to class E up to 250 MHz for all data services up to 48 V d.c. and protects four pairs (**Figure 11**).

Alternatively, a DEHNpatch DPA M CAT6 RJ45S 48 arrester can be used to protect the 100 MB Ethernet data lines. This surge protective device is a prewired standard patch cable with integrated surge arrester.

Whether the signal lines for the pitch system must be protected by surge protective devices depends on the sensors used which may have different parameters depending on the manufacturer. If, for example, sensors supplied with 24 V d.c. or



Figure 10 Protection of wind measurement equipment (anemometer)

lower voltages are used, BLITZDUCTOR BXT ML4 BE 24 surge arresters are ideally suited to protect these signal lines. These arresters can be installed in conformity with the lightning protection zone concept at the boundaries from LPZ 0_A to LPZ 2 and higher. Surge protective devices should be installed on both sides, namely in the pitch system and in the controller.

Condition monitoring

The availability of wind turbines, especially that of offshore wind turbines, increasingly gains importance. Therefore, lightning current and surge arresters must be monitored for signs of pre-damage (condition monitoring).

The specific use of condition monitoring allows to plan service work, thus reducing costs.

BLITZDUCTOR XT arresters for information technology systems with integrated LifeCheck feature are a simple and ideal monitoring system that detects pre-damage at an early stage and allows to replace pre-damaged arresters in the next service interval. LifeCheck permanently monitors the status of the arresters free of potential since the LifeCheck status is read out via contactless RFID technology. Like an early warning system, LifeCheck reliably detects imminent electrical or thermal overload of the protection components. A stationary condition monitoring system allows condition-based maintenance of 10 BLITZDUCTOR XT arresters.

Two systems are available:

1. DRC MCM XT (**Figure 11**) – Compact DIN rail mounted multiple condition monitoring system for condition monitoring:
 - ➔ Condition monitoring of LifeCheck-equipped arresters

White Paper

Lightning and surge protection for wind turbines



Figure 11 Example of surge protective devices in a pitch system

- ➔ Cascaded system permanently monitors up to 150 arresters (600 signal cores)
 - ➔ Minimal wiring
 - ➔ Remote signalling via RS485 or remote signalling contacts (1 break and 1 make contact)
2. DRC SCM XT – Single condition monitoring system ideally suited for small-sized wind turbines with max. ten arresters:
- ➔ Condition monitoring of LifeCheck-equipped arresters
 - ➔ Monitoring of up to 10 arresters (40 signal cores)
 - ➔ Minimal wiring
 - ➔ Remote signalling via remote signalling contact (1 break contact)

As is the case with the condition monitoring systems of the BLITZDUCTOR XT series, all arrester systems of the DEHNguard or DEHNblock series with the addition "FM" can be optionally monitored via a floating contact. In case of DEHNguard arresters with the addition "LI" (Lifetime Indication), the visual indication indicates three operating states, namely yellow (end of service life), green (fully functional) and red (faulty). If the yellow indicator flag appears, the module has reached about 80% of its service life. In addition to the visual indication at the module, this signal to replace the arrester is also transmitted to the turbine controller via the remote signalling contact in the next service interval.

Laboratory tests according to IEC-61400-24

IEC 61400-24 describes two basic methods to perform system-level immunity tests for wind turbines:



Figure 12 Customer-specific testing in the impulse current laboratory

- ➔ When performing impulse current tests under operating conditions, impulse currents or partial lightning currents are injected into the individual lines of a control system while mains voltage is present. Thus, the equipment to be protected including all SPDs is subjected to an impulse current test.
- ➔ The second test method simulates the electromagnetic effects of the LEMP. To this end, the full lightning current is injected into the structure which discharges the lightning current and the behaviour of the electrical system is analysed by means of simulating the cabling under operating conditions as realistically as possible. The lightning current steepness is a decisive test parameter.

DEHN offers engineering and test services (**Figure 12**) for wind turbine manufacturers such as:





- ➔ Lightning current tests for bearings and gearboxes of the mechanical drive string
 - ➔ High-current tests for the receptors and down conductors of rotor blades
 - ➔ System-level immunity tests for important control systems such as pitch systems, wind sensors or aircraft warning lights
 - ➔ Testing of customer-specific connection units
- The IEC 61400-24 standard recommends to carry out such system tests for important control systems.

White Paper

Lightning and surge protection for wind turbines



Products and technical data





DEHNmid		
	Type	DMI 9 10 1
	Part No.	990 003
	Rated voltage (a.c.) (U_r)	9 kV
	Max. continuous operating voltage (a.c.) (U_C)	7.2 kV
	Nominal discharge current (8/20 μ s) (I_n)	10 kA
	High current impulse (4/10 μ s)	100 kA
	Line discharge class	1 (2.8 kJ/kV $_{Ur}$)
	Type	DMI 36 10 1
	Part No.	990 013
	Rated voltage (a.c.) (U_r)	36 kV
	Max. continuous operating voltage (a.c.) (U_C)	28.8 kV
	Nominal discharge current (8/20 μ s) (I_n)	10 kA
	High current impulse (4/10 μ s)	100 kA
	Line discharge class	1 (2.8 kJ/kV $_{Ur}$)
DEHNbloc		
	Type	DB M 1 440 FM
	Part No.	961 145
	SPD acc. to EN 61643-11/IEC 61643-11	Type 1 / Class I
	Max. continuous operating voltage (a.c.) (U_C)	440 V
	Nominal discharge current (8/20 μ s) (I_n)	35 kA
	Voltage protection level (U_p)	≤ 2.5 kV
DEHNSolid		
	Type	DSO 1 255
	Part No.	900 230
	SPD acc. to EN 61643-11/IEC 61643-11	Type 1 / Class I
	Max. continuous operating voltage (a.c.) (U_C)	255 V
	Lightning impulse current (10/350 μ s) (I_{imp})	200 kA
	Voltage protection level (U_p)	≤ 2.5 kV
	Follow current extinguishing capability (a.c.) (I_{fi})	3 kA $_{rms}$

White Paper

Lightning and surge protection for wind turbines



DEHNguard

	Type	DG M TN 275 FM
	Part No.	952 205
	SPD acc. to EN 61643-11/IEC 61643-11	Typ 2 / Class II
	Max. continuous operating voltage (a.c.) (U_C)	275 V
	Nominal discharge current (8/20 μ s) (I_n)	20 kA
Voltage protection level (U_p)	≤ 1.5 kV	
	Type	DG M TNC 275 FM
	Part No.	952 305
	SPD acc. to EN 61643-11/IEC 61643-11	Type 2 / Class II
	Max. continuous operating voltage (a.c.) (U_C)	275 V
	Nominal discharge current (8/20 μ s) (I_n)	20 kA
Voltage protection level (U_p)	≤ 1.5 kV	
	Type	DG M TNC CI 275 FM
	Part No.	952 309
	SPD acc. to EN 61643-11/IEC 61643-11	Type 2 / Class II
	Max. continuous operating voltage (a.c.) (U_C)	275 V
	Nominal discharge current (8/20 μ s) (I_n)	12.5 kA
Voltage protection level (U_p)	≤ 1.5 kV	
	Type	DG M WE 600 FM
	Part No.	952 307
	SPD acc. to EN 61643-11 / IEC 61643-11	Type 2 / Class II
	Max. continuous operating voltage (a.c.) (U_C)	600 V
	Nominal discharge current (8/20 μ s) (I_n)	15 kA
Voltage protection level (U_p)	≤ 3 kV	

Impulse Counter

	Type	P 2
	Part No.	910 502
	Response threshold for impulse currents	> 1 kA
	Sequence of impulses	1 s
	Power supply	9 V battery

White Paper

Lightning and surge protection for wind turbines



Type 2 NEPTUNE circuit (for doubly-fed induction generators only)



Type (set)	SET SN1673	
Part No. (set)	989 410	
Type	DG 1000 FM	TFS SN1638
Part No.	950 112	900 222/S
SPD acc. to EN 61643-11/IEC 61643-11	Type 2 / Class II	
SPD according to EN 50164-3		Class H 100 kA (10/350 µs)
Nominal voltage (a.c.) (U_n)	1000 V	
Max. continuous operating voltage (a.c.) (U_c)	1000 V	
Nominal discharge current (I_n)	15 kA/path	
Max. total discharge current (I_{max})		100 kA
Voltage protection level [L-L]/[L-PA] (U_p)	< 8.4 kV / < 10 kV	
Max. overcurrent protection up to 1000 V a.c.	100 A aM	
Max. overcurrent protection at $U < 690$ V a.c.	125 A gG	
Short-circuit withstand capability for max. backup fuse	25 kA	

BLITZDUCTOR



Type	BXT BAS	
Part No.	920 300	
For mounting on	35 mm DIN rails according to EN 60715	
Cross-sectional area (solid / flexible)	0.08 – 4 mm ² / 0.08 – 2.5 mm ²	
Earthing via	35 mm DIN rails according to EN 60715	

BLITZDUCTOR SP



Type	BSP M4 BE 24	
Part No.	926 324	
SPD class	TYPE 2 P1	
Nominal voltage (U_N)	24 V	
Max. continuous operating voltage (d.c.) (U_C)	33 V	
Max. continuous operating voltage (a.c.) (U_C)	23.3 V	
C2 Nominal discharge current (8/20 µs) total / per line (I_n)	20 kA / 10 kA	
Cut-off frequency line-PG (f_G)	6.8 MHz	

White Paper

Lightning and surge protection for wind turbines



BLITZDUCTOR XT



Type	BXT ML4 BE 24
Part No.	920 324
SPD class/SPD monitoring	TYPE 1 P1 / LifeCheck
Nominal voltage (U_N)	24 V
Max. continuous operating voltage (d.c.) (U_C)	33 V
Max. continuous operating voltage (a.c.) (U_C)	23.3 V
D1 Lightning impulse current (10/350 μ s) total/per line (I_{imp})	10 kA/2.5 kA
C2 Nominal discharge current (8/20 μ s) total/per line (I_n)	20 kA/10 kA
Cut-off frequency line-PG (f_G)	6.8 MHz



Type	BXT ML2 BE S 24
Part No.	920 224
SPD class/SPD monitoring	TYPE 1 P1 / LifeCheck
Nominal voltage (U_N)	24 V
Max. continuous operating voltage (d.c.) (U_C)	33 V
Max. continuous operating voltage (a.c.) (U_C)	23.3 V
D1 Lightning impulse current (10/350 μ s) total/per line (I_{imp})	9 kA/2.5 kA
C2 Nominal discharge current (8/20 μ s) total/per line (I_n)	20 kA/10 kA
Cut-off frequency line-PG (f_G)	6.8 MHz

DEHNconnect





Type	DCO SD2 ME 24
Part No.	917 921
SPD class	TYPE 2 P1
Nominal voltage (U_N)	24 V
Max. continuous operating voltage (d.c.) (U_C)	33 V
Max. continuous operating voltage (a.c.) (U_C)	23 V
C2 Nominal discharge current (8/20 μ s) total/per line (I_n)	10 kA/5 kA
Cut-off frequency line-PG (f_G)	6 MHz

White Paper



Lightning and surge protection for wind turbines



Condition Monitoring

	Type	DRC MCM XT
	Part No.	910 695
	SPD monitoring	LifeCheck
	Number of BLITZDUCTOR modules to be monitored	150 (RS485 bus up to 15 DRC MCM XT and thus monitoring up to 150 modules)
	Programmable	RS485
	Type	DRC SCM XT
	Part No.	910 696
	SPD monitoring	LifeCheck
	Number of BLITZDUCTOR modules to be monitored	10
	Programmable	No

Test Device

	Type	DRC LC M3+
	Part No.	910 653
	SPD monitoring	LifeCheck
	Data transfer to PC	Yes
	Programming via module	Yes
	Type	DRC LC M1+
	Part No.	910 655
	SPD monitoring	LifeCheck
	Data transfer to PC	No
	Programming via module	No

DEHNpatch

	Type	DPA M CAT6 RJ45S 48	DPA M CLE RJ45B 48
	Part No.	929 110	929 121
	SPD class	TYPE 2 P1	
	Nominal voltage (U_N)	48 V	
	Max. cont. operating voltage (d.c./a.c.) (U_C)	48 V / 34 V	
	Max. continuous operating voltage (d.c.) pair-pair (PoE) (U_C)	57 V	
	Nominal current (I_N)	1 A	
	C2 Total nominal discharge current (8/20 μ s) line-line / line-PG / line-PG (I_N)	150 A / 2.5 kA / 10 kA	
	C2 Nominal discharge current (8/20 μ s) pair-pair (PoE) (I_N)	150 A	

White Paper

Lightning and surge protection for wind turbines



HVI®power Conductor



Type	HVI PO 90 27 L6M SW
Part No.	819 160
Material of conductor	Cu
Material of coating / insulation	PE
Colour of conductor	Black
Cross-section of core	25 mm ²
Equivalent separation distance s (in air)	≤ 90 cm
Outer diameter of conductor	27 mm

HVI®power long Conductor

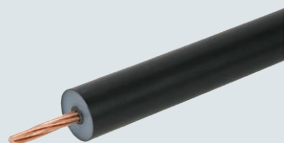

Type	HVI P LO 90 27 TR100M SW
Part No.	819 137
Material of conductor	Cu
Material of coating / insulation	PE
Colour of conductor	Black
Cross-section of core	25 mm ²
Equivalent separation distance s (in air)	≤ 90 cm
Outer diameter of conductor	27 mm

HVI®long Conductor



Type	HVI LO 75 20 TR100M SW M
Part No.	819 135
Material of conductor	Cu
Material of coating / insulation	PVC/PE
Colour of conductor	Black
Cross-section of core	19 mm ²
Equivalent separation distance s (in air)	≤ 75 cm
Outer diameter of conductor	20 mm

HVI®light Conductor



Type	HVI LI 45 20 L100M GR
Part No.	819 125
Material of conductor	Cu
Material of coating / insulation	PVC/PE
Colour of conductor	Grey
Cross-section of core	19 mm ²
Equivalent separation distance s (in air)	≤ 45 cm
Outer diameter of conductor	20 mm

White Paper

Lightning and surge protection for wind turbines



Equipotential Bonding Bar

	Type	PAS I 6AP M10 V2A
	Part No.	472 209
	Number of terminals	6
	Material bar/screw/nut	StSt
	Dimensions (l x w x d)/cross-section	295 x 40 x 6 mm / 240 mm ²
	Short-circuit current (50 Hz) (1 s; ≤ 300 °C)	8.9 kA

Fixed Earthing Terminal

	Part No.	478 011
	Thread	M10/M12
	Plate material	StSt (V4A)
	Material No.	AISI/ASTM 316 Ti/316 L/316
	Axle material	St/tZn
	Short-circuit current (50 Hz) (1 s; ≤ 300 °C)	6.5 kA

Pressure U-Clamp

	Part No.	308 031
	Material	St/bare
	Clamping range Rd/Rd	(+II) 6-20/6-10 mm
	Clamping range Rd/FI	(+II) 6-20/30 x 3-4 mm
	Clamping range FI/FI	(+II) 30 x 3-4/30 x 3-4 mm
	Short-circuit current (50 Hz) (1 s; ≤ 300 °C)	8.4 kA

Cross Unit

	Part No.	319 209
	Material/Material No.	StSt (V4A)/AISI/ASTM 316 Ti/316 L/316
	Clamping range Rd/Rd; (stranded/cable)	8-10/8-10 mm; 50-70 mm ²
	Clamping range Rd/FI; FI/FI	8-10/30 mm; 30/30 mm
	Short-circuit current (50 Hz) (1 s; ≤ 300 °C)	7 kA

MAXI-MV Clamp with UL467B Approval

	Part No.	308 040
	Material	St/bare
	Clamping range Rd	8-16/15-25 mm
	Material thickness	3.0/2.0 mm
	Short-circuit current (50 Hz) (1 s; ≤ 300 °C)	10.2 kA

White Paper

Lightning and surge protection for wind turbines



Pipe Clamp for Air-Termination Rods

	Part No.	540 105
	Material	StSt
	Clamping range square hollow profile / pipe	40 x 60 to 70 x 70 mm / 50 – 300 mm
	Connection Rd	16 mm
	Dimensions tensioning strap / strip	1100 x 25 x 0.3 mm / 25 x 0.3 mm

Air-Termination Rod

	Part No.	103 449
	Total length (l1); diameter	3000 mm; 16/10 mm
	Material	StSt

Stainless Steel Wire

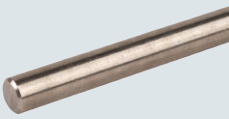
	Part No.	860 010
	Conductor diameter / cross-section	10 mm / 78 mm ²
	Material / Material No.	StSt (V4A) / AISI / ASTM 316 Ti / 316 L
	Short-circuit current (50 Hz) (1 s; ≤ 300 °C)	2.9 kA

Steel Strip

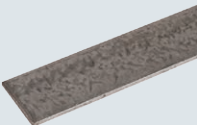
	Part No.	810 335
	Width / thickness / cross-section	30 mm / 3.5 mm / 105 mm ²
	Material	St/tZn
	Short-circuit current (50 Hz) (1 s; ≤ 300 °C)	7.3 kA

For more products and details please visit www.dehn-international.com.



**Surge Protection
Lightning Protection
Safety Equipment
DEHN protects.**

DEHN + SÖHNE
GmbH + Co.KG.

Hans-Dehn-Str. 1
Postfach 1640
92306 Neumarkt
Germany

Tel. +49 9181 906-0
Fax +49 9181 906-1100
info@dehn.de
www.dehn-international.com



www.dehn-international.com/partners

Type designations of products mentioned in the white paper being at the same time registered trademarks are not especially marked. So if there is no marking of TM or [®] this does not mean that the type designation is a free trade name. Neither it can be seen whether patents or utility models and other intellectual and industrial property rights are available. We reserve the right to introduce changes in performance, configuration and technology, dimensions, weights and materials in the course of technical progress. The figures are shown without obligation. Misprints, errors and modifications excepted. Reproduction in any form whatsoever is forbidden without our authorisation.

actiVsense, BLITZDUCTOR, BLITZPLANER, DEHN, DEHN Logo, DEHN schützt, DEHNbloc, DEHNfix, DEHNgrip, DEHNguard, DEHNport, DEHNQUICK, DEHNrapid, DEHNshield, DEHNSnap, DEHNventil, HVI, LifeCheck, Red/Line are protected by German Trade Mark, by Community Trade Mark (EU) and/or in other countries.