



# White Paper

Lightning and surge protection for free field  
PV power plants



## Contents

- Measures for protecting PV power plants from lightning interference
- Air-termination system and down conductors
- Earth-termination system
- Lightning equipotential bonding
- Systems of the external lightning protection system
- Cable routing
- Surge protection measures
- Special surge protective devices for PV systems
- Decentralised string inverters
- Information technology systems

# White Paper

## Lightning and surge protection for free field PV power plants



With an annual newly installed capacity of some gigawatts, free field PV power plants are becoming an integral part of modern power supply systems in many countries. Today large-scale power plants with a capacity of 100 MW and higher are installed which are directly connected to the medium and high-voltage level. As an integral part of a power supply system, photovoltaic systems must ensure stable grid operation. In addition, possible production losses, which negatively affect the annual performance ratio of the power plant, are recorded by the yield monitoring system. Consequently, the investment volume and a minimum service life of 20 years require that the risk resulting from a lightning strike be assessed and protection measures be taken.

### Risk of a lightning strike to structures such as PV power plants

There is a connection between the solar radiation, air humidity and frequency of lightning discharges. Regions with a high solar radiation and air humidity are more susceptible to lightning strikes. The regional lightning frequency (lightning strikes per square kilometres/year) and the location and size of the PV power plant form the basis for calculating the probability of lightning strikes to the plant. PV systems are exposed to local weather conditions such as thunderstorms over decades.

### Necessity of a lightning protection system

Damage to PV systems is caused both by the destructive effects of a direct lightning strike and inductive or capacitive coupling of voltages caused by the electromagnetic lightning field. Moreover, voltage peaks resulting from switching operations on the upstream a.c. system can cause damage to PV modules, inverters, charge controllers and their monitoring and communication systems.

Economic damage leads to replacement and repair costs, yield loss and costs for using the reserve power of the power plant. Lightning impulses also cause premature ageing of bypass diodes, power semiconductors and the input and output circuits of data systems, which leads to increased repair costs.

In addition, utilities place requirements on the availability of the energy produced. In Germany, these requirements are based on e.g. the new Grid Codes. Banks and insurance companies frequently also require to consider lightning protection measures in due diligence analyses. The German VdS brochure 2010 (risk-oriented lightning and surge protection) published by the German Insurance Association (GDV) requires that lightning protection measures (class of LPS III) be taken for PV

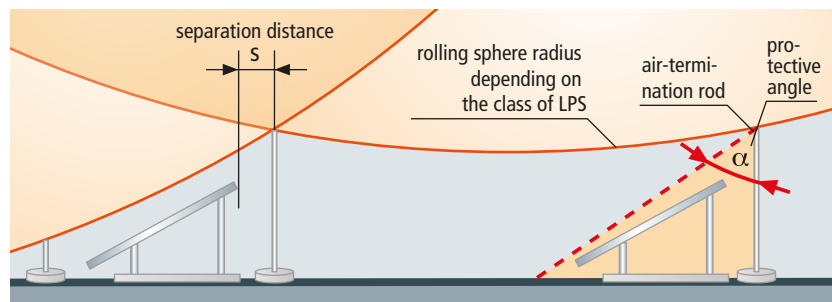

Figure 1 Rolling sphere method versus protective angle method for determining the protected volume



Figure 2 Lightning protection by means of DEHNiso spacers

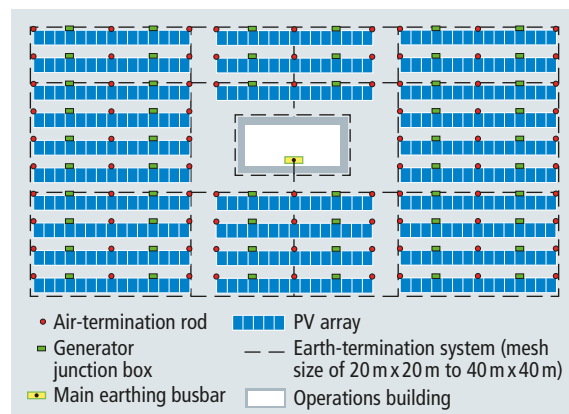

Figure 3 Earth-termination system as per IEC 62305-3 (EN 62305-3)

# White Paper

## Lightning and surge protection for free field PV power plants



systems > 10 kW of objects with alternative renewable power supply systems.

The risk resulting from a lightning strike must be determined according to the IEC 62305-2 (EN 62305-2) standard and the results of this risk analysis must be considered at the design stage. For this purpose, DEHN + SÖHNE offers the DEHNsupport software. A risk analysis performed by means of this software ensures a technically and economically optimised lightning protection concept which is understood by all parties involved and offers the necessary protection at reasonable costs.

### Measures for protecting PV power plants from lightning interference

To ensure effective protection, a lightning protection system with optimally coordinated elements (air-termination system, earth-termination system, lightning equipotential bonding, surge protective devices for power supply and data systems) is required.

### Air-termination system and down conductors

To prevent direct lightning strikes to the electrical systems of a PV power plant, these systems must be located in the protected volume of air-termination systems. Design according to the German VdS guideline 2010 is based on class of LPS III. According to this class of LPS, the rolling sphere method (**Figure 1**) as per IEC 62305-3 (EN 62305-3) can be used to determine the number of air-termination rods. These air-termination rods form a protected volume above modules, service rooms and

cables. Due to the inductive coupling of interference, it is advisable to install generator junction boxes mounted on module substructures and decentralised inverters as far as possible from air-termination systems. The high masts on which CCTV systems are installed also act as air-termination systems. The CCTV system itself must be mounted in such a way that it is located in the protected volume of the mast. All down conductors of these air-termination systems must be connected to the terminal lugs of the earth-termination system. Terminal lugs must be corrosion-resistant (stainless steel (V4A), e.g. material No. AISI/ASTM 316 Ti) due to the risk of corrosion at the point where they leave the soil or concrete. Terminal lugs made of galvanised steel must be protected by adequate measures, e.g. Denso tapes or heat shrinkable sleeves.

To mechanically fix the air-termination systems, they can be frequently connected to the module substructures. To this end, DEHNiso spacers can be used (**Figure 2**). The air-termination systems can be connected to the earth-termination system via pile-driven foundations, thus facilitating maintenance of the premises.

### Earth-termination system

An earth-termination system (**Figure 3**) forms the basis for implementing effective lightning and surge protection measures in PV power plants. In Annex D of Supplement 5 of the German DIN EN 62305-3 (VDE 0185-305-3) standard, an earth resistance  $R_A$  of less than  $10 \Omega$  is recommended for an earth-termination system. A meshed 10 mm stainless steel wire (20 m x 20 m to 40 m x 40 m) buried below the frost

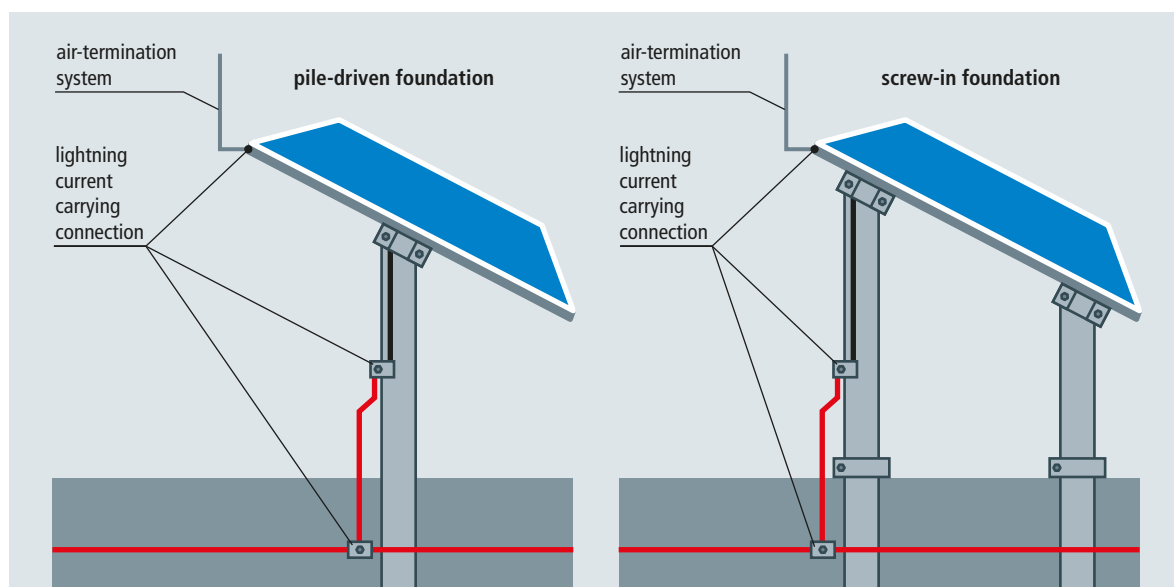

Figure 4 Pile-driven and screw-in foundation with a lightning current carrying connection between the air-termination system and the earth-termination system



# White Paper

## Lightning and surge protection for free field PV power plants



line is durable and has proven its worth in practice. The metal module substructures can be used as part of the mesh if they have a minimum conductance according to the IEC 62305-3 (EN 62305-3) standard. Supplement 5 of the German DIN EN 62305-3 (VDE 0185-305-3) standard recommends that metal substructures be interconnected. The mesh is frequently installed according to the existing cable trenches and should be closed. The IEC 61936-1 and EN 50522 standards must be particularly observed for the earth-termination systems of the operations buildings. The earth-termination systems of the PV generators and the operations buildings must be interconnected by means of a flat strip (30 mm x 3.5 mm) or a round wire ( $\varnothing$  10 mm) (stainless steel (V4A), e.g. material No. AISI/ASTM 316 Ti, or copper or galvanised steel). This interconnection of the individual earth-termination systems reduces the total earth resistance. By intermeshing the earth-termination systems, an equipotential surface is created which considerably reduces the voltage stress on the electrical connecting lines in case of lightning interference between the PV array and the operations building. To permanently keep the earth resistance stable over the many years of operation of a PV power plant, the influences of corrosion, soil moisture and frost must be taken into account. Only the areas below the frost line must be considered for the effective earth electrode length. The meshes must be interconnected via adequate lightning-current-tested connection components. The metal module substructures on which the PV modules are installed must be connected to each other and to the earth-termination system. Frame constructions with a pile-driven or screw-in foundation can be used as earth electrodes (Figure 4) if they have the material and wall thickness specified in Table 7 of the IEC 62305-3 (EN 62305-3) standard. The required minimum length of 2.5 m in the area below the frost line can be added in case of interconnected lightning-current-proof individual elements. Each PV array must be interconnected in such a way that they can carry lightning currents, for example by means of a



Figure 5 UNI saddle clamp

10 mm stainless steel wire (e.g. material No. AISI/ASTM 316 Ti) and a UNI saddle clamp (Figure 5).

### Lightning equipotential bonding

Lightning equipotential bonding means directly connecting all metal systems in such a way that they can carry lightning currents. If the modules and cables, the operations building with the weather station are located in the protected volume of the external lightning protection system, it is not to be expected that direct lightning currents are injected into the lines. If the connection to the utility power grid is established on the low-voltage level, this point is connected to the main earthing busbar (MEB) via type 1 lightning current arresters (e.g. DEHNventil) since partial lightning currents are present. The same applies to the incoming telecommunication cables for which type 1 arresters such as BLITZDUTOR or DEHNbox (Figure 6) must be installed.

### Solar generator and systems of the external lightning protection system

The air-termination systems of the external lightning protection system are vital. In case of an uncontrolled lightning strike to the PV system, lightning currents will flow into the electrical installation and cause severe damage to the system. When installing the external lightning protection system, it must be observed that solar cells are not shaded, for example, by air-termination rods. Diffuse shadows, which occur in case of distant rods or conductors, do not negatively affect the PV system and the yield. Core shadows, however, unnecessarily stress the cells and the associated bypass diodes. The required distance can be calculated and depends on the diameter of the air-termination rod. For example, if an air-termination rod with a diameter of 10 mm shades a module, only a diffuse shadow is cast on the module if a distance of 1.08 m is maintained between the module and the air-termination rod. Annex A of Supplement 5 of the German DIN EN 62305-3 standard provides more detailed information on the calculation of core shadows.

### Cable routing in PV systems

All cables must be routed in such a way that large conductor loops are avoided. This must be observed for the single-pole series connections of the d.c. circuits (string) and for the interconnection of several strings. Moreover, data or sensor lines must not be routed across several strings and form large conductor loops with the string lines. For this reason, power (d.c. and a.c.), data and equipotential bonding conductors must be routed together as far as practicable.

### Surge protection measures for PV power plants

Surge protective devices (SPDs) (Figure 6) must be installed to protect the electrical systems in PV power plants. In case of

# White Paper

## Lightning and surge protection for free field PV power plants

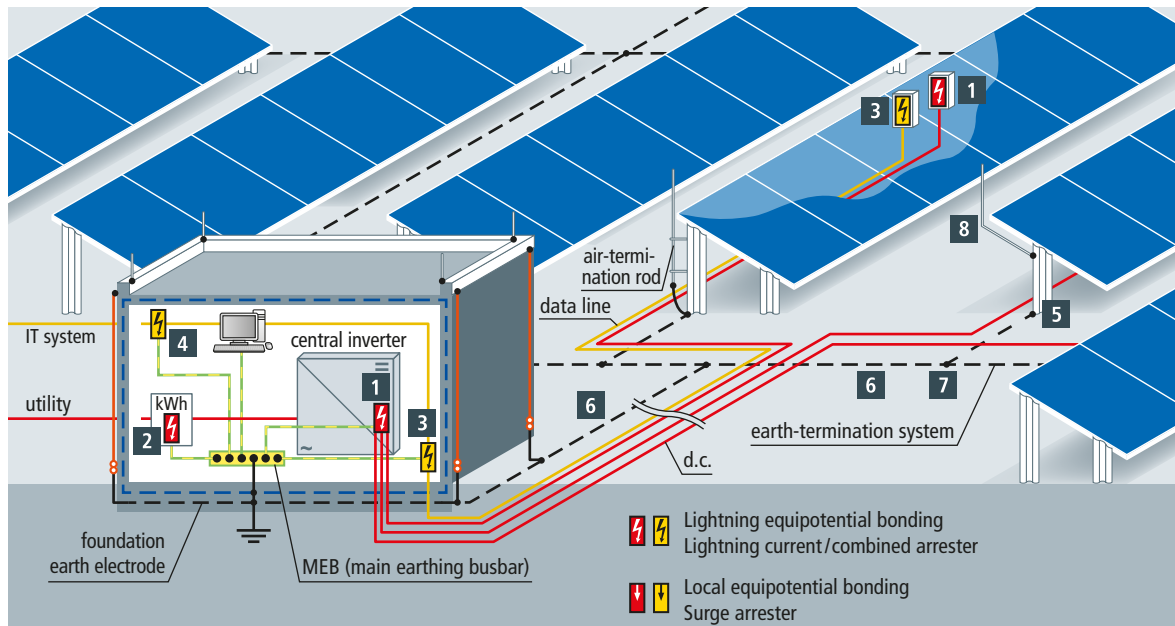

No. in Fig.	Protection for	SPD	*FM = Floating remote signalling contact	Part No.
<b>d.c. input of the inverter</b>				
1	Central inverter + GJB	DEHNcombo DCB YPV 1500 FM*		900 067
<b>a.c. side of the grid connection</b>				
2	TN-C system	DEHNventil DV M TNC 255 FM*		951 305
	TN-S system	DEHNventil DV M TNS 255 FM*		951 405
	TT system	DEHNventil DV M TT 255 FM*		951 315
<b>Data interface</b>				
3	One pair, even with operating voltages up to 180 V	BLITZDUCTOR BXTU ML2 BD 0-180 + BXT BAS base part		920 249 + 920 300
<b>Remote maintenance</b>				
4	ISDN or DSL	DEHNbox DBX U4 KT BD S 0-180		922 400
<b>Earth-termination system</b>				
5	Equipotential bonding	UNI saddle clamp		365 250
6	Earthing conductor	Round wire (Ø 10 mm) St/tZn		800 310
		Round wire (Ø 10 mm) StSt (V4A)		860 010
		Strip steel (30 x 3.5 mm) St/tZn		852 335
		Strip steel (30 x 3.5 mm) StSt (V4A)		860 325
7	Connection element	MV clamp StSt (V4A)		390 079
		alternative: SV clamp St/tZn		308 220
8	Air-termination system	Angled air-termination tip (including two saddle clamps)		101 110

Figure 6 Lightning protection concept for a PV power plant with central inverter

# White Paper

## Lightning and surge protection for free field PV power plants

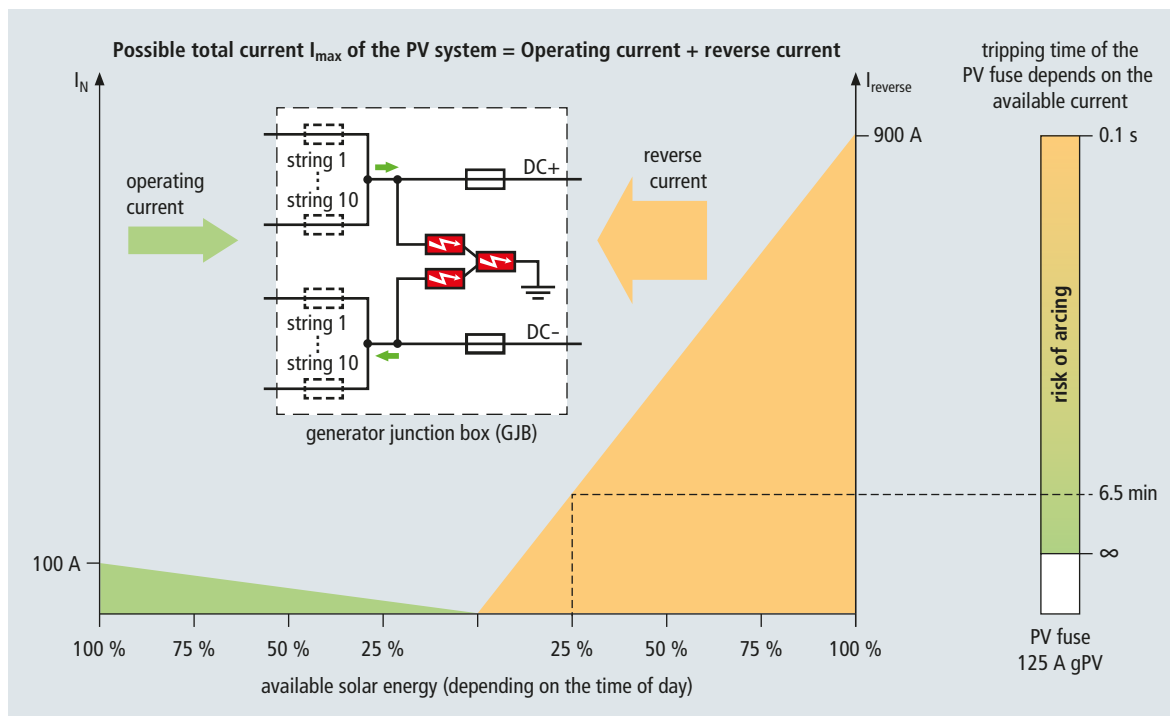

Figure 7 PV system with  $I_{max}$  of 1000 A: Prospective short-circuit current at the PV arrester depending on the time of day

a lightning strike to the external lightning protection system of a free field PV system, high voltage impulses are induced on all electrical conductors and partial lightning currents flow into all sort of park cables (d.c., a.c. and data cables). The magnitude of the partial lightning currents depends on, for example, the type of earth-termination system, soil resistivity on site and the type of cables. In case of power plants with central inverters (Figure 6), extended d.c. cables are routed in the field. Annex D of Supplement 5 of the German DIN EN 62305-3 (VDE 0185-305-3) standard requires a minimum discharge capacity  $I_{total}$  of 10 kA (10/350  $\mu$ s) for voltage-limiting type 1 d.c. SPDs. SPDs with a sufficiently high short-circuit current rating  $I_{SCPV}$ , which is determined by means of the EN 50539-11 standard and must be specified by the manufacturer, must be used. This also applies with respect to possible reverse currents. In PV systems with central inverters, fuses protect from reverse currents. The maximum available current depends on the actual solar radiation. In certain operating states, fuses only trip after some minutes (Figure 7). Therefore, surge protective devices installed in generator junction boxes must be designed for the possible total current consisting of the operating current and the reverse current and ensure automatic disconnection without arcing in case of overload ( $I_{SCPV} > I_{max}$  of the PV system).

### Special surge protective devices for the d.c. side of PV systems

The typical U/I characteristic curves of photovoltaic current sources are very different from that of conventional d.c. sources: They have a non-linear characteristic (Figure 8) and a different d.c. arc behaviour. This unique nature of photovoltaic

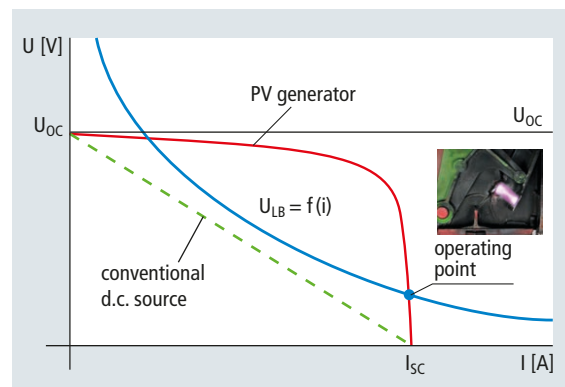

Figure 8 Source characteristic of a conventional d.c. source versus the source characteristic of a PV generator. When switching PV sources, the source characteristic of the PV generator crosses the arc voltage range.

# White Paper

## Lightning and surge protection for free field PV power plants



Class of LPS and maximum lightning current (10/350 $\mu$ s)		Values for voltage-limiting or type 1 combined SPDs (series connection)				Values for voltage-switching or type 1 combined SPDs (parallel connection)	
		$I_{10/350}$		$I_{8/20}$		$I_{10/350}$	
		Per protective path [kA]	$I_{total}$ [kA]	Per protective path [kA]	$I_{total}$ [kA]	Per protective path [kA]	$I_{total}$ [kA]
III and IV	100 kA	5	10	15	30	10	20

Table 1 Minimum discharge capacity of voltage-limiting or type 1 combined SPDs and voltage-switching type 1 SPDs for free field PV systems in case of LPL III; according to CENELEC CLC/TS 50539-12 (Table A.3)

current sources does not only affect the design and size of PV d.c. switches and PV fuses, but also requires that the surge protective devices are adapted to this unique nature and capable of coping with PV d.c. follow currents. Supplement 5 of the German DIN EN 62305-3 standard and the CENELEC CLC/TS 50539-12 standard require safe operation of surge protective devices on the d.c. side even in case of overload.

Supplement 5 of the German DIN EN 62305-3 standard includes a more detailed assessment of the lightning current distribution by means of computer simulations as described in Supplement 1 of the German DIN EN 62305-4 standard. To calculate the lightning current distribution, the down conductors of the lightning protection system, possible earth connections of the PV array and the d.c. lines must be considered. It is shown that the magnitude and amplitude of the partial lightning currents flowing via the SPDs into the d.c. lines does not only depend on the number of down conductors, but is also influenced by the impedance of the SPDs. The impedance of the SPDs depends on the rated voltage of the SPDs, the SPD topology and the type of SPD (voltage-switching or voltage-limiting). The reduction of the pulse form is characteristic of partial lightning currents flowing via SPDs on the d.c. side of the PV system. When selecting adequate surge protective devices, both the maximum impulse current and the impulse load must be considered. These correlations are described in Supplement 1 of the German DIN EN 62305-4 standard.

To facilitate the selection of adequate arresters, **Table 1** shows the required lightning impulse current carrying capability  $I_{imp}$  of type 1 SPDs depending on the type of SPD (voltage-limiting varistor-based arrester or voltage-switching spark-gap-based arrester). The maximum impulse currents and partial lightning currents of 10/350  $\mu$ s wave form are considered to ensure that the SPDs are capable of discharging the impulse load of the lightning currents.

In addition to the tried and tested fault-resistant Y circuit, DEHNcombo YPV SCI ... (FM) also features a three-step d.c. switching device (**Figure 9**). This d.c. switching device consists of a combined disconnection and short-circuiting device with

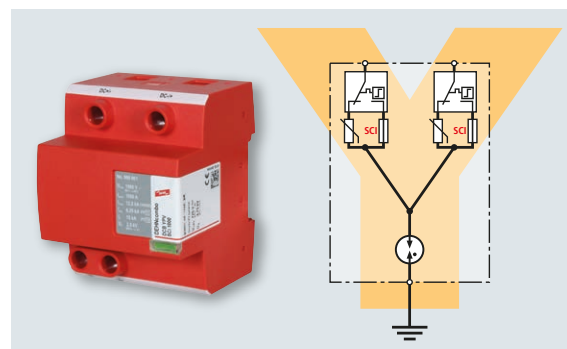

Figure 9 DEHNcombo YPV SCI type 1 + type 2 combined arrester with fault-resistant Y circuit and three-step d.c. switching device

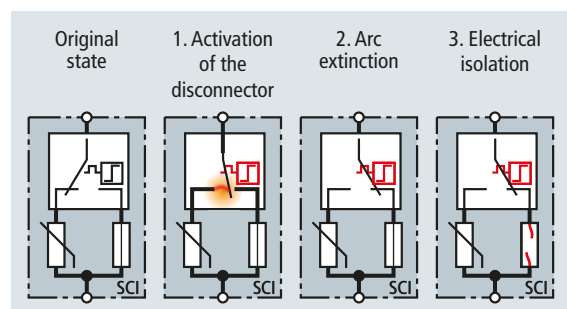

Figure 10 Switching phases of the three-step d.c. switching device integrated in DEHNcombo YPV SCI ... (FM)

Thermo Dynamic Control. The fuse integrated in the bypass path interrupts the current flow in case of a fault and puts the entire unit into a safe state (**Figure 10**). Thus, DEHNcombo YPV SCI ... (FM), which is installed at the inverter or in the generator junction box (GJB), reliably protects PV generators up to 1000 A without backup fuse (**Figure 11**). DEHNcombo YPV SCI is available for 600 V, 1000 V and 1500 V. If string monitoring systems are used, the floating remote signalling



# White Paper

## Lightning and surge protection for free field PV power plants

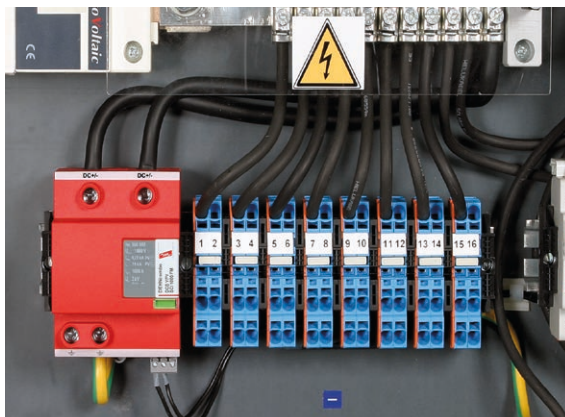

Figure 11 Surge protective device in a monitoring generator junction box

contacts for condition monitoring of the SPDs can be integrated in these monitoring systems.

The combination of the numerous technologies integrated in the DEHNcombo YPV SCI combined arrester prevents damage to surge protective devices due to insulation faults in the PV circuit, minimises the risk of fire of an overloaded arrester and puts the arrester in a safe electrical state without disrupting the operation of the PV system. Thanks to the protective circuit, the voltage-limiting characteristic of varistors can now be fully used in the d.c. circuits of PV systems and the arrester also

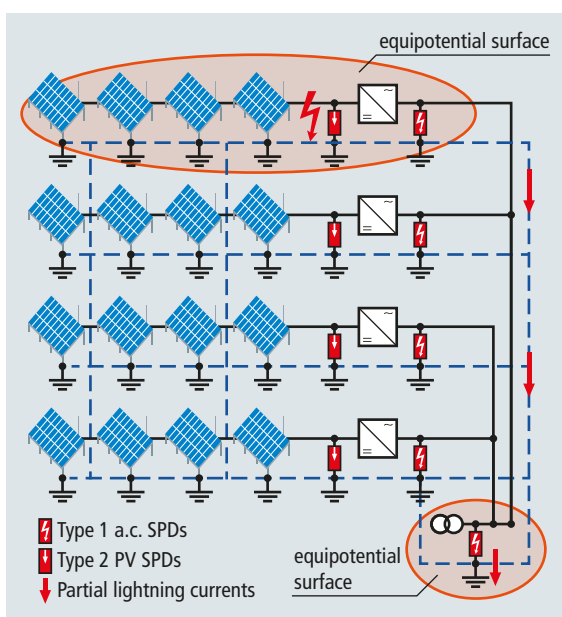

Figure 12 Lightning current distribution in case of free field PV systems with string inverter

operates in case of numerous small voltage peaks. Thus, the SCI technology increases the service life of the bypass diodes and the d.c. inputs of the inverters.

### PV power plants with decentralised string inverters

If PV power plants with decentralised string inverters are used, most of the power cables are installed on the a.c. side. The inverters are installed in the field underneath the module substructures of the relevant solar generators. Due to the proximity to the modules, the inverter assumes typical functions of generator junction boxes. Supplement 5 of the German DIN EN 62305-3 standard describes that the lightning current distribution is influenced by the power cables (string or central inverter). In addition to Supplement 5, **Figure 12** exemplarily shows the lightning current distribution in case string inverters. If string inverters are installed, the power cables are also used as equipotential bonding conductor between the local earth potential of the PV array hit by lightning and the remote equipotential surface of the infeed transformer. The only difference from plants with central inverters is that in case of PV systems with string inverters the partial lightning currents flow into the a.c. lines. Therefore, type 1 arresters are installed on the a.c. side of the string inverters and on the low-voltage side of the infeed transformer. **Table 1** shows the minimum discharge capacity of type 1 SPDs depending on the SPD technology. Type 2 SPDs such as DEHNcube YPV SCI are sufficient for the d.c. side of string inverters. If an earth-termination system according to Supplement 5 is installed, the string inverters and the PV array connected to them form a local equipotential surface so that it is not to be expected that lightning currents are injected into the d.c. lines since the arresters limit induced interference. They thus also protect the modules in close proximity from surges. Several a.c. outputs of these outdoor inverters are collected and stored in a.c. boxes. If type 1 arresters such as DEHNshield ... 255 are installed there, these devices protect all inverter outputs up to a distance of 10 m (conducted). Further a.c. field cables are routed into the operations building. The powerful type 1 and type 2 DEHNventil combined arrester protects the electrical equipment for the grid connection point at this point. Other equipment such as the grid and plant protection, alarm panel or web server which is located less than 10 m (conducted) from this SPD is also protected.

### Surge protection measures for information technology systems

Data from the field as well as data acquired from remote maintenance by the plant operator and capacity measurements and control by the grid operator are collected in operations buildings. To ensure that the service staff is able to specifically determine causes of failure via remote diagnostics and



# White Paper

## Lightning and surge protection for free field PV power plants

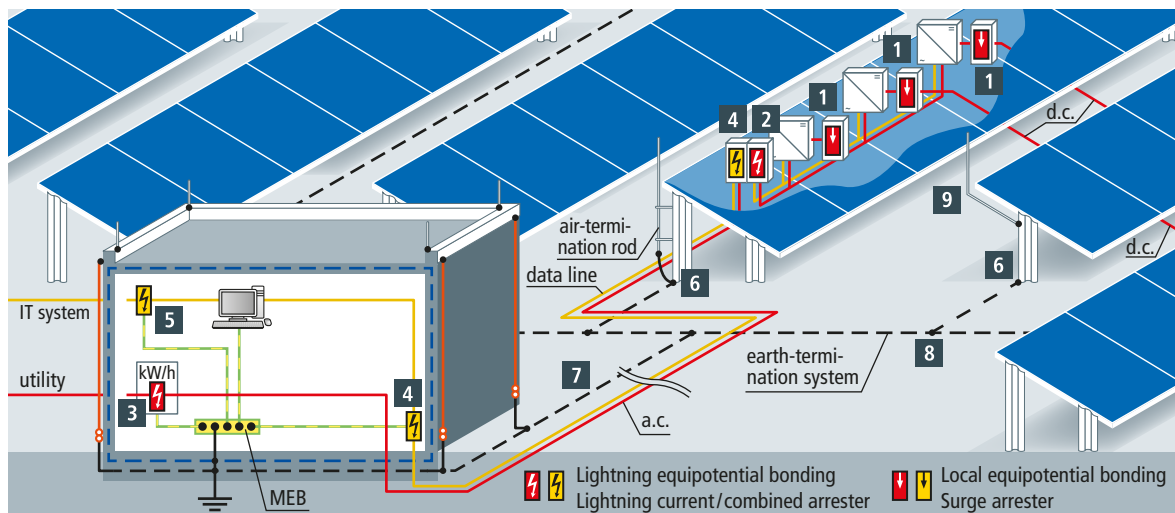

No. in Figure	Protection for	SPD	* FM = Floating remote signalling contact	Part No.
<b>d.c. input of the inverter</b>				
1	For 1 MPPT	DEHNcube DCU YPV SCI 1M		900 910
	For 2 MPPTs	DEHNcube DCU YPV SCI 2M		900 920
	Per MPPT	DEHNguard DG M YPV SCI 1000 FM		952 515
<b>a.c. side of the inverter</b>				
2	TN-S system	DEHNshield DSH TNS 255		941 400
<b>a.c. side of the grid connection</b>				
3	TN-C system	DEHNventil DV M TNC 255 FM*		951 305
	TN-S system	DEHNventil DV M TNS 255 FM*		951 405
	TT system	DEHNventil DV M TT 255 FM*		951 315
<b>Data interface</b>				
4	One pair, with operating voltages up to 180 V	BLITZDUCTOR BXTU ML2 BD 0-180 + BXT BAS base part		920 249 + 920 300
<b>Remote maintenance</b>				
5	ISDN or DSL	DEHNbox DBX U4 KT BD S 0-180		922 400
<b>Earth-termination system/external lightning protection system</b>				
6	Equipotential bonding	UNI saddle clamp		365 250
7	Earthing conductor	Round wire (Ø 10 mm) St/tZn		800 310
		Round wire (Ø 10 mm) St/St (V4A)		860 010
		Strip steel (30 x 3,5 mm) St/tZn		852 335
		Strip steel (30 x 3,5 mm) St/St (V4A)		860 325
8	Connection element	MV clamp St/St (V4A)		390 079
		alternative: SV clamp St/tZn		308 220
9	Air-termination system	Angled air-termination tip (including 2 saddle clamps)		101 110

Figure 13 Lightning protection concept for a PV power plant with string inverter

# White Paper

## Lightning and surge protection for free field PV power plants

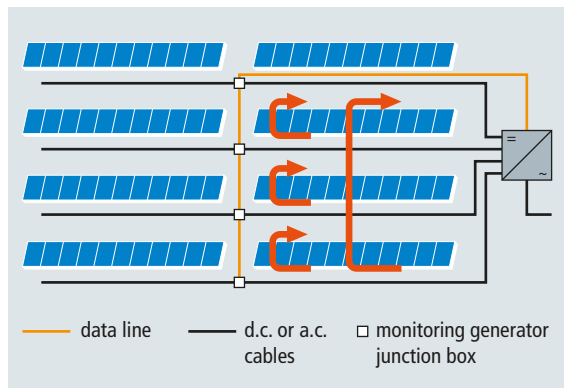

Figure 14 Basic principle of induction loops in PV power plants

eliminate them on site, reliable data transfer must be ensured at any time. The string and inverter monitoring, weather data acquisition, anti-theft protection and external communication are based on different physical interfaces. Wind and radiation sensors with analogue signal transmission can be protected by DEHNbox DBX. Thanks to its actiVsense technology, DEHNbox DBX can be used for signal voltages up to 180 V and automatically adapts the voltage protection level. BLITZDUCTOR XT is ideally suited to protect an RS 485 interface for communication between the inverters. DEHNgate BNC VC devices are used to protect CCTV systems with coaxial video transmission which is used for anti-theft protection systems. If the sub-stations of large-scale PV power plants are interconnected via Ethernet, DEHNpatch M CAT6, which can also be used for PoE (Power over Ethernet) applications, can be installed. No matter if it is an ISDN or ADSL connection - the data lines of devices which

provide a connection to the outside world are also protected by the relevant surge protective devices.

In case of power plants with central inverters, generator junction boxes with additional measuring sensors are installed in the field. In case of power plants with string inverters (**Figure 13**), their integrated string monitoring system takes over this task. In both cases, the measured values from the field are transmitted via data interfaces. The data lines from the service room are installed together with the power cables (a.c. or d.c.). Due to the short line lengths of field bus systems, data cables are individually routed transversely to the module substructures. In case of a direct lightning strike, these transverse connections also carry partial lightning currents which may damage the input circuits and cause flashover to power cables. Large induction loops are formed due to the interaction of power cables, metal module substructure rows and data lines (**Figure 14**). This is an ideal environment for transients caused by lightning discharges which can be injected into these lines. Such voltage peaks are capable of exceeding the insulation strength/dielectric strength of these systems which leads to surge damage. Therefore, SPDs must be installed in these monitoring generator junction boxes or in the decentralised string inverters to protect data transmission. Cable shields must be connected to all connection points in line with the EN 50174-2 standard (section 5.3.6.3). This can also be achieved by indirect shield earthing to prevent malfunction such as ripples and stray currents. BLITZDUCTOR XT, for example, can be used together with an EMC spring terminal of type SAK BXT LR for indirect shield earthing.



Consistent lightning and surge protection for all systems allows to considerably increase the performance ratio of these power plants. The service and maintenance time as well as repair and spare part costs are reduced.

# White Paper

Lightning and surge protection for free field  
PV power plants



## Products and technical data

d.c. side		
<b>DEHNcombo</b>		
	Type	DCB YPV SCI 1500 FM
	Part No.	900 067
	SPD acc. to EN 50539-11	Type 1 + Type 2
	Max. PV voltage [DC+ → DC-]/[DC+/DC → PE] ( $U_{CPV}$ )	$\leq 1500\text{ V}/\leq 1100\text{ V}$
	Short-circuit current rating ( $I_{SCPV}$ )	1000 A
	Nominal discharge current (8/20 $\mu\text{s}$ ) ( $I_n$ )	15 kA
	Total discharge current (10/350 $\mu\text{s}$ ) [DC+/ DC- → PE] ( $I_{total}$ )/[DC+ → PE/DC- → PE] ( $I_{imp}$ )	12.5 kA/6.25 kA
	Voltage protection level [(DC+/DC-) → PE]/[DC+ → DC-] ( $U_p$ )	3.75 kV/7.25 kV
<b>DEHNcube</b>		
	Type	DCU YPV SCI 1000 1M
	Part No.	900 910
	SPD acc. to EN 50539-11	Type 2
	Maximum PV voltage ( $U_{CPV}$ )	$\leq 1000\text{ V}$
	Short-circuit current rating ( $I_{SCPV}$ )	1000 A
	Total discharge current (8/20 $\mu\text{s}$ ) [(DC+/DC-) → PE] ( $I_{total}$ )	40 kA
	Nominal discharge current (8/20 $\mu\text{s}$ ) ( $I_n$ )	12.5 kA
	Maximum discharge current (8/20 $\mu\text{s}$ ) [(DC+/DC-) → PE] ( $I_{max}$ )	25 kA
Voltage protection level ( $U_p$ )	$\leq 4\text{ kV}$	
Degree of protection	IP 65	
	Type	DCU YPV SCI 1000 2M
	Part No.	900 920
	SPD acc. to EN 50539-11	Type 2
	Maximum PV voltage ( $U_{CPV}$ )	$\leq 1000\text{ V}$
	Short-circuit current rating ( $I_{SCPV}$ )	1000 A
	Total discharge current (8/20 $\mu\text{s}$ ) [(DC+/DC-) → PE] ( $I_{total}$ )	40 kA
	Nominal discharge current (8/20 $\mu\text{s}$ ) ( $I_n$ )	12.5 kA
	Maximum discharge current (8/20 $\mu\text{s}$ ) [(DC+/DC-) → PE] ( $I_{max}$ )	25 kA
Voltage protection level ( $U_p$ )	$\leq 4\text{ kV}$	
Degree of protection	IP 65	





# White Paper



Lightning and surge protection for free field  
PV power plants



## Connecting cables for DEHNcube

	Type	AL DCU X PV L600	AL DCU X PV L1000
	Part No.	900 946	900 947
	For connecting	2 strings	
	Cross-sectional area	6 mm <sup>2</sup>	
	Degree of protection	IP 65	
	Length (1) [→ inverter]	600 mm	1000 mm
	Length (2) [→ DEHNcube]	300 mm	
	Length (3) [→ +/- string]	100 mm	
	Type	AL DCU Y PV L600	AL DCU X PV L1000
	Part No.	900 948	900 949
	For connecting	1 string	
	Cross-sectional area	6 mm <sup>2</sup>	
	Degree of protection	IP 65	
	Length (1) [→ inverter]	600 mm	1000 mm
	Length (2) [→ DEHNcube]	300 mm	
	Length (3) [→ +/- string]	100 mm	

## DEHNguard

	Type	DG M YPV SCI 1000 FM
	Part No.	952 515
	SPD acc. to EN 50539-11	Type 2
	Maximum PV voltage (U <sub>CPV</sub> )	≤ 1000 V
	Short-circuit current rating (I <sub>SCPV</sub> )	1000 A
	Nominal discharge current (8/20 μs) [(DC+/DC-) → PE] (I <sub>n</sub> )	12.5 kA
	Voltage protection level (U <sub>p</sub> )	≤ 4 kV
		

## a.c. side of the inverter

### DEHNshield

	Type	DSH TNS 255
	Part No.	941 400
	SPD acc. to EN 61643-11 / IEC 61643-11	Type 1+ Type 2 / Class I + Class II
	Max. continuous operating voltage (a.c.) (U <sub>C</sub> )	255 V
	Lightning impulse current (10/350 μs) [L1+L2+L3+N-PE] (I <sub>total</sub> )	50 kA
	Lightning impulse current (10/350 μs) [L, N-PE] (I <sub>imp</sub> )	12.5 kA
	Voltage protection level [L-PE] / [N-PE] (U <sub>p</sub> )	≤ 1.5 / ≤ 1.5 kV



# White Paper

Lightning and surge protection for free field  
PV power plants



## a.c. side of the grid connection

### DEHNventil

	Type	DV M TNC 255 FM
	Part No.	951 305
	SPD acc. to EN 61643-11 / IEC 61643-11	Type 1+ Type 2 / Class I + Class II
	Max. continuous operating voltage (a.c.) ( $U_C$ )	264 V
	Lightning impulse current (10/350 $\mu$ s) [L1+L2+L3-PEN] ( $I_{total}$ ) / [L-PEN] ( $I_{imp}$ )	75 kA / 25 kA
	Voltage protection level ( $U_p$ )	$\leq 1.5$ kV
	Type	DV M TT 255 FM
	Part No.	951 315
	SPD acc. to EN 61643-11 / IEC 61643-11	Type 1+ Type 2 / Class I + Class II
	Max. continuous operating voltage (a.c.) ( $U_C$ )	264 V
	Lightning impulse current (10/350 $\mu$ s) [L1+L2+L3+N-PE] ( $I_{total}$ ) /	100 kA
	Lightning impulse current (10/350 $\mu$ s) [L-N] / [N-PE] ( $I_{imp}$ )	25 / 100 kA
Voltage protection level [L-N] / [N-PE] ( $U_p$ )	$\leq 1.5$ kV / $\leq 1.5$ kV	
	Type	DV M TNS 255 FM
	Part No.	951 405
	SPD acc. to EN 61643-11 / IEC 61643-11	Type 1+ Type 2 / Class I + Class II
	Max. continuous operating voltage (a.c.) ( $U_C$ )	264 V
	Lightning impulse current (10/350 $\mu$ s) [L1+L2+L3+N-PE] ( $I_{total}$ ) / [L, N-PE] ( $I_{imp}$ )	100 kA / 25 kA
	Voltage protection level [L-PE] / [N-PE] ( $U_p$ )	$\leq 1.5$ kV / $\leq 1.5$ kV

## Data interface

### BLITZDUCTOR XTU



	Type	BXTU ML2 BD S 0-180
	Part No.	920 249
	SPD class / SPD monitoring	<b>TYPE 1P1</b> / LifeCheck
	Operating voltage ( $U_N$ )	0-180 V
	Max. cont. operating voltage (d.c. / a.c.) ( $U_C$ )	180 V / 127 V
	D1 Lightning impulse current (10/350 $\mu$ s) total / per line ( $I_{imp}$ )	9 kA / 2.5 kA
	C2 Nominal discharge current (8/20 $\mu$ s) total / per line ( $I_n$ )	20 kA / 10 kA
	Voltage protection level line-line for $I_{imp}$ D1 ( $U_p$ )	$\leq U_N + 53$ V
	Voltage protection level line-PG for C2/C3/D1	$\leq 550$ V
	Test standards	IEC 61643-21 / EN 61643-21, UL 497B

# White Paper

## Lightning and surge protection for free field PV power plants



### BLITZDUCTOR XT

	Type	BXT BAS
	Part No.	920 300
	For mounting on	35 mm DIN rails acc. to EN 60715
	Cross-sectional area (solid / flexible)	0.08–4 mm <sup>2</sup> / 0.08–2.5 mm <sup>2</sup>
	Type	AK BXT LR
	Part No.	920 395
	Plugs into	BXT BAS / BSP BAS 4 clamp connection

### DEHNpatch

	Type	DPA M CAT6 RJ45S 48
	Part No.	929 110
	SPD class	<b>TYPE 2 P1</b>
	Nominal voltage (U <sub>N</sub> )	48 V
	Max. cont. operating voltage (d.c./a.c.) (U <sub>C</sub> )	48 V / 34 V
	Max. continuous operating voltage (d.c.) pair-pair (PoE) (U <sub>C</sub> )	57 V
	Nominal current (I <sub>I</sub> )	1 A
	C2 Total nominal discharge current (8/20 μs) line-line / line-PG / line-PG (I <sub>n</sub> )	150 A / 2.5 kA / 10 kA
	C2 Nominal discharge current (8/20 μs) pair-pair (PoE) (I <sub>n</sub> )	150 A
	Voltage protection level: line-line / line-PG for I <sub>n</sub> C2 (U <sub>p</sub> ) / pair-pair for I <sub>n</sub> C2 (PoE) (U <sub>p</sub> )	≤ 190 V / ≤ 600 V / ≤ 600 V
	Voltage protection level: line-line / line-PG at 1 kV/μs C3 (U <sub>p</sub> ) / pair-pair at 1 kV/μs C3 (PoE) (U <sub>p</sub> )	≤ 145 V / ≤ 500 V / ≤ 600 V

### DEHNgate

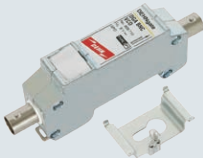
	Type	DGA BNC VCD
	Part No.	909 710
	SPD class	<b>TYPE 2 P1</b>
	Nominal voltage (U <sub>N</sub> )	5 V
	Max. cont. operating voltage (d.c.) (U <sub>C</sub> )	6.4 V
	Nominal current (I <sub>I</sub> )	0.1 A
	D1 Lightning impulse current (10/350 μs) (I <sub>imp</sub> )	1 kA
	C2 Nominal discharge current (8/20 μs) shield-PG / line-shield (I <sub>n</sub> )	10 kA / 5 kA
	Voltage protection level: line-shield for I <sub>n</sub> C2 (U <sub>p</sub> ) / pair-pair for I <sub>n</sub> C2 (PoE) (U <sub>p</sub> )	≤ 35 V / ≤ 600 V
	Voltage protection: level line-shield at 1 kV/μs C3 (U <sub>p</sub> ) / pair-pair at 1 kV/μs C3 (PoE) (U <sub>p</sub> )	≤ 13 V / ≤ 600 V



# White Paper

## Lightning and surge protection for free field PV power plants



### Data interface

#### DEHNbox



Type	DBX U4 KT BD S 0-180
Part No.	922 400
SPD class	<b>TYPE 1 P1</b>
Nominal voltage ( $U_N$ )	0-180 V
D1 Lightning impulse current (10/350 $\mu$ s) total/per line ( $I_{imp}$ )	10 kA/2.5 kA
C2 Nominal discharge current (8/20 $\mu$ s) total/per line ( $I_n$ )	20 kA/10 kA
Voltage protection level line-line for $I_{imp}$ D1 ( $U_p$ )	$\leq U_N + 50$ V
Voltage protection level line-PG for D1/C2/C3	$\leq 550$ V

### Earth-termination system / external lightning protection system

#### UNI saddle clamp



Part No.	365 250
Clamping range of the saddle	0.7–8 mm
Clamping range Rd	8–10 mm
Connection (solid/stranded)	4–50 mm <sup>2</sup>
Material of the clamping bracket	Al
Material of the double cleat/screw/nut	StSt

#### SV clamp

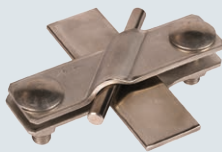

Part No.	308 220
Clamping range Rd/Rd	7–10/7–10 mm
Clamping range Rd/Fl	7–10/30 mm
Clamping range Fl/Fl	30/30 mm
Material of the clamp/screw/nut	St/tZn

#### Round wire / strip steel

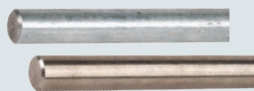

Part No.	800 310	860 010
Conductor diameter / cross-section	10 mm / 78 mm <sup>2</sup>	
Material	St/tZn	StSt (V4A)

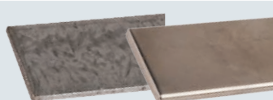

Part No.	852 335	860 325
Width/thickness/cross-section	30 mm / 3.5 mm / 105 mm <sup>2</sup>	
Material	St/tZn	StSt (V4A)

#### Angled air-termination tip (including two saddle clamps)



Part No.	101 110
Total length	1000 mm
Material	Al
Diameter	10 mm



**Surge Protection  
Lightning Protection  
Safety Equipment  
DEHN protects.**

DEHN + SÖHNE  
GmbH + Co.KG.

Hans-Dehn-Str. 1  
Postfach 1640  
92306 Neumarkt  
Germany

Tel. +49 9181 906-0  
Fax +49 9181 906-1100  
info@dehn.de  
[www.dehn-international.com](http://www.dehn-international.com)



[www.dehn-international.com/partners](http://www.dehn-international.com/partners)

Type designations of products mentioned in the white paper being at the same time registered trademarks are not especially marked. So if there is no marking of <sup>TM</sup> or <sup>®</sup> this does not mean that the type designation is a free trade name. Neither it can be seen whether patents or utility models and other intellectual and industrial property rights are available. We reserve the right to introduce changes in performance, configuration and technology, dimensions, weights and materials in the course of technical progress. The figures are shown without obligation. Misprints, errors and modifications excepted. Reproduction in any form whatsoever is forbidden without our authorisation.

actiVsense, BLITZDUCTOR, BLITZPLANER, DEHN, DEHN Logo, DEHN schützt, DEHNbloc, DEHNfix, DEHNgrip, DEHNguard, DEHNport, DEHNQUICK, DEHNrapid, DEHNshield, DEHNSnap, DEHNventil, HVI, LifeCheck, Red/Line are protected by German Trade Mark, by Community Trade Mark (EU) and/or in other countries.